



Gas and Flame Detection

Operation and Maintenance Manual

GDS-68SXP Natural Gas Odorant Monitor
GDS-68SXP Process Monitor

GDS Corp

1245 Butler Road • League City, TX 77573

409-927-2980 • 409-927-4180 (Fax) • www.gdscorp.com

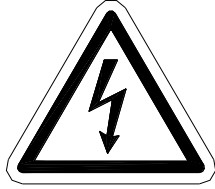

CAUTION: FOR SAFETY REASONS THIS EQUIPMENT MUST BE OPERATED AND SERVICED BY QUALIFIED PERSONNEL ONLY. READ AND UNDERSTAND INSTRUCTION MANUAL COMPLETELY BEFORE OPERATING OR SERVICING.

ATTENTION: POUR DES RAISONS DE SÉCURITÉ, CET ÉQUIPEMENT DOIT ÊTRE UTILISÉ, ENTRETENU ET RÉPARÉ UNIQUEMENT PAR UN PERSONNEL QUALIFIÉ. ÉTUDIER LE MANUE D'INSTRUCTIONS EN ENTIER AVANT D'UTILISER, D'ENTRETENIR OU DE RÉPARER L'ÉQUIPEMENT.

REVISION HISTORY

Revision 1.0	4/25/18	Initial release for Version 1.01 system firmware
Revision 1.02	10/11/18	Updated for Version 1.02a system firmware & tubing configuration
Revision 1.03	04/07/19	Updated for Version 1.03 system firmware
Revision 1.04	08/01/19	Updated for Version 1.04 system firmware

Copyright © 2018 GDS Corp. All Rights Reserved

P/N 1200-0985-0104

1 CONTENTS

1	CONTENTS	3
2	TABLE OF FIGURES.....	4
3	SAFETY INFORMATION	5
4	GENERAL INFORMATION	6
5	SPECIFICATIONS	7
6	THEORY of OPERATION	8
7	INSTALLATION.....	10
8	STARTUP PROCEDURE	16
9	GDS-68SXP USER INTERFACE.....	17
10	GASMAX CX USER INTERFACE	21
11	CALIBRATION OVERVIEW.....	22
12	SYSTEM CALIBRATION	25
13	SYSTEM CALIBRATION PROCEDURE (CAL GAS).....	27
14	SYSTEM CALIBRATION PROCEDURE (STREAM).....	28
15	GAS SENSOR CALIBRATION PROCEDURE	29
16	MAINTENANCE.....	31
17	GDS-68SXP USER MENUS.....	36
18	GASMAX CX USER MENUS	44
19	GDS-68SXP MODBUS REGISTERS.....	50
20	TROUBLESHOOTING GUIDELINES	54
21	GDS CONNECT 68SXP APPLICATION FOR iPhone.....	56
22	SYSTEM DIMENSIONS.....	57
23	GASMAX CX FACTORY DEFAULT SETUP	58
24	SYSTEM EVENTS	61
25	KNOWN ERRATA	63

2 TABLE OF FIGURES

FIGURE 6-1: FUNCTIONAL BLOCK DIAGRAM	8
FIGURE 6-2 MEASUREMENT SEQUENCE	9
FIGURE 7-1 GDS-68SXP WIRING JUNCTION BOX.....	11
FIGURE 7-2: 200W AC HEATER WIRING	12
FIGURE 9-1 GDS-68SXP USER INTERFACE.....	17
FIGURE 9-2 GDS-68SXP MAIN SCREEN	17
FIGURE 9-3 LAST READINGS SCREEN	18
FIGURE 9-4 SYSTEM STATUS SCREENS	19
FIGURE 9-5 MAIN MENU ACCESS	20
FIGURE 9-6 MAIN MENU STRUCTURE	20
FIGURE 10-1 GASMAX CX DISPLAY	21
FIGURE 11-1 CALIBRATION SETUP (DEMAND FLOW REGULATOR).....	23
FIGURE 11-2: CALIBRATION SETUP (FIXED FLOW REGULATOR).....	23
FIGURE 11-3 CALIBRATION SETUP (PERMANENT DF REGULATOR)	24
FIGURE 12-1 MANUAL SYSTEM CALIBRATION	25
FIGURE 16-1 RESTORE FACTORY SETTINGS SCREENS.....	35
FIGURE 21-1: GDS CONNECT IOS APP	56
FIGURE 22-1: GDS-68SXP DIMENSIONS WITH WALL-MOUNT KIT	57

3 SAFETY INFORMATION

Users should read and develop a detailed understanding these GDS-68SXP Process / Odorant Monitor operating and maintenance instructions before attempting to operate the unit. Use the GDS-68SXP Process / Odorant Monitor only as specified in this manual for the detection of gases in streams of natural gas or other gases.

WARNINGS

- The GDS-68SXP Process / Odorant Monitor described in this manual must be installed, operated and maintained in accordance with information contained herein.
- Installation in any hazardous area must comply with all applicable restrictions, requirements and guidelines for said hazardous areas. It is the end user customer's final decision to ensure that the GDS-68SXP Process / Odorant Monitor is suitable for the intended use.
- The GDS-68SXP Process / Odorant Monitor is designed and constructed to measure the level of certain gases in backgrounds that contain low amounts of free oxygen. Accuracy in atmospheres containing steam or inert gases cannot be guaranteed.
- Do not paint enclosure, enclosures or sensor assembly.
- Do not operate the GDS-68SXP Process / Odorant Monitor if its enclosure is damaged or cracked or has missing components. Make sure the covers of the explosion proof enclosures are securely in place before applying power.
- Do not expose the GDS-68SXP Process / Odorant Monitor to electrical shock or continuous severe mechanical shock.
- Protect the GDS-68SXP Process / Odorant Monitor from dripping liquids and high-power water spray.
- Calibrate with known target gas during start-up and check on a regular schedule, at least every 90 days. More frequent inspections are encouraged to spot problems such as dirt, oil, paint, grease or other foreign materials in the sample tubing or in the sensor head.
- Use only for applications described within this manual.

4 GENERAL INFORMATION

The GDS-68SXP Process / Odorant Monitor provides a safe and reliable way to measure the levels of hydrogen, hydrogen sulfide, mercaptan, THT and mixed odorants in streams of natural gas. The 68SXP is designed for unattended operation and can measure gas or odorant in the range of 0-15 parts-per-million (ppm), 0-50.0 milligrams per cubic meter (mg/m³) or 0-3.00 pounds per million cubic feet (lbs/mmcf).

The completely automated measurement cycle eliminates human error and produces an accurate reading that can be repeated on one, two, four, six, eight, 12 or 24-hour intervals.

The GDS-68SXP Process / Odorant Monitor contains multiple microprocessor controllers that manage the measurement cycle and automatically detect and report system errors such as blocked flow, expired sensors or over-range inputs.

The 68SXP offers both 4-20mA analog output and serial RS-485 MODBUS output. An extensive MODBUS database allows remote users to access system status, measurement data, calibration data and more.

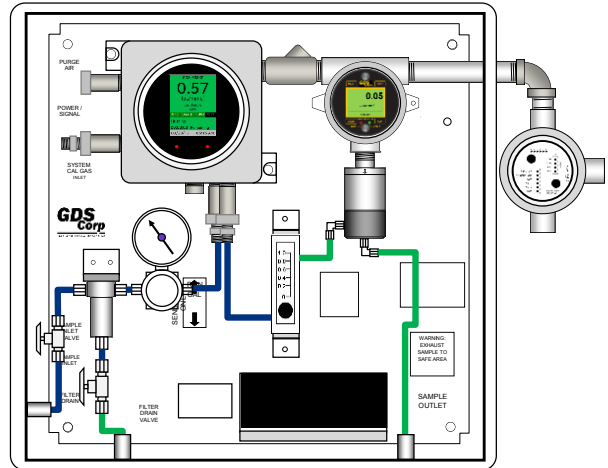

In addition to fully autonomous operation, the GDS-68SXP can be programmed for periodic automatic calibration using a separate Cal Gas Inlet port and locally connected bottle of calibration gas. Automatic calibration can be programmed to occur on daily, weekly, monthly or quarterly intervals.

An iOS wireless application ("*GDS Connect*") is available from the Apple App Store that allows a user to remotely interrogate and command a GDS-68SXP from up to 25 feet away. Security settings allow both MODBUS and wireless communications to be enabled, restricted to read-only or totally disabled.

The GDS-68SXP Process / Odorant Monitor is designed for use in Class 1 Division 1 hazardous areas and is constructed using stainless steel tubing and fittings, explosion proof enclosures and high-quality industrial components. The GDS-68SXP utilizes the industry-recognized GASMAX CX gas for real-time measurement of the amount of odorant present in the natural gas stream.

EXPLOSION PROOF INSTALLATION

The GDS-68SXP Process / Odorant Monitor is designed for use in hazardous areas. Installation in these areas should follow best industry standard practices and all appropriate electrical codes. Generally, these codes require rigid metal conduit, poured seals and other installation elements necessary to ensure safety. For maximum protection against RF interference or electrical surge, the GDS-68SXP back-panel and interconnecting conduit must be properly grounded.

INTRINSICALLY SAFE INSTALLATION

The GDS-68SXP is not designed or certified for use as an Intrinsically Safe device.

5 SPECIFICATIONS

Model	GDS-68SXP Process / Odorant Monitor
Power Input	24VDC \pm 5% at < 12 watts 200W @ 110VAC required for optional enclosure heater Dedicated wiring junction box for easy connection to power and signals
System Controller	Dedicated 32-bit microprocessor with FLASH rom and high resolution 320x240 color LCD.
Sample Period	Sample period from 4 samples / hour to one sample per 24 hours.
Gas Sensor	GASMAX CX High Performance Gas Monitor with Hydrogen, Hydrogen Sulfide, Mercaptan, THT or custom electrochemical sensor; includes fault monitoring, temperature compensation and user-prompted calibration
Sample Inlet	High pressure / standard filter: +10 psig to +1000 psig
Cal Gas Inlet	Vacuum draw at 0.5 to 1.0 LPM. Requires calibration gas cylinder with demand flow regulator.
Accuracy	+/- 3% of full scale (typical)
Standard Output	Three-wire 4-20mA current source outputs with fault and over-range indication. Maximum loop resistance is 750 ohms. RS-485 serial two-wire MODBUS slave interface & wireless interface
Temperature (operating)	0°C to +50°C with NEMA 4X enclosure. -20°C to +50°C with NEMA 4X enclosure and optional 200W enclosure heater. Fixed heater thermostat preset to 50°F Optional high temp heater (100°F) available
Temperature (inert)	-20°C to +55°C with NEMA 4X enclosure. In cold weather, GDS Corp recommends turning on the AC heater (if installed) for several hours before applying DC power
Memory	On-board non-volatile memory retains all user settings. Rolling event log with 128 entries stores time-stamped events and readings.
Materials	Instrument housings: Aluminum Rigid tubing & fittings 316 stainless steel or Tygon flexible tubing
Dimensions	NEMA 4x non-metallic enclosure, outside dimensions 25.6" x 25.6" x 10.8"
Approvals	GASMAX CX Gas Monitor CSA Certified Class I, Div 1 & 2 Groups B, C, D. Sequencer enclosure CSA certified for use in Class I Div 1 areas. Flame arrestors UL certified for use in Class 1 Div 1 areas.
Warranty	Two years on electronics

6 THEORY OF OPERATION

The GDS-68SXP Process / Odorant Monitor periodically applies sample gas to an electrochemical sensor, records and displays the peak reading, purges the sensor with clean air and repeats the process on intervals programmed by the operator. This technique maximizes accuracy, increases sensor life and reduces the total amount of gas released to the atmosphere.

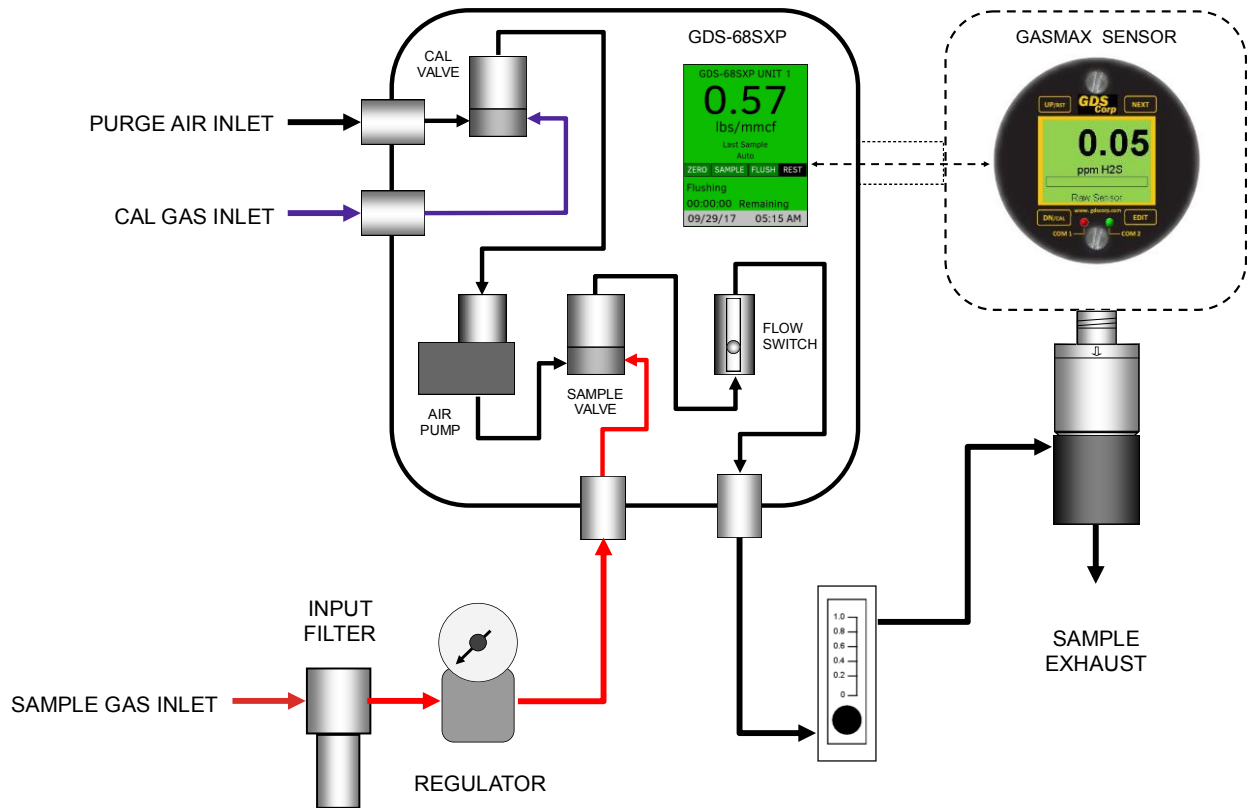

Figure 6-1: Functional Block Diagram

Under normal conditions while resting, ambient air is forced into the sensor via the CAL VALVE and AIR PUMP. At the beginning of each measurement cycle a zero-reference measurement is made; once the zero reading is recorded, the SAMPLE VALVE is opened, allowing gas from the SAMPLE GAS INLET to flow through the FLOW SWITCH, FLOW METER and into the SENSOR. During this time, the CONTROLLER monitors the GAS DETECTOR output and FLOW SWITCH to identify and store the peak value and verify sample flow through the system. Once this peak value has been found, the SAMPLE VALVE is closed, and the AIR PUMP is turned back on to flush the sample gas and residual odorant from the sensor. After the reading falls below a preset threshold and all measurement cycle error checks are complete, the measured value is transferred to the CONTROLLER display.

When running a *gas sensor* or *system calibration*, reference gas is connected via the CAL GAS INLET using a DEMAND FLOW REGULATOR. During a *gas sensor* calibration gas is applied manually while during *system calibration* gas is automatically applied to the sensor as needed during the calibration cycle.

A typical measurement or system calibration cycle is shown below. At the beginning of the cycle, a small amount of gas is optionally injected into the sensor (“Bump”), then the sensor is allowed to rest for several minutes, during which the resting zero is measured (“Zero”). The sample valve is then turned on (“Inject”) and the gas sensor output begins to increase. After a fixed minimum time, a peak-find algorithm in the GDS-68SXP is used to determine the peak reading value (“Peak”). Once the peak value is stored, the sample valve is closed, and the air pump is turned on to flush the methane gas and odorant from the sensor (“Flush”).

Once the GASMAX output drops below 10% of scale, and no cycle errors are detected, then the calculated value is transferred to the display, analog output, wireless database and MODBUS register database. The unit then rests (“Rest”) until the beginning of the next sample (Optional “Bump”).

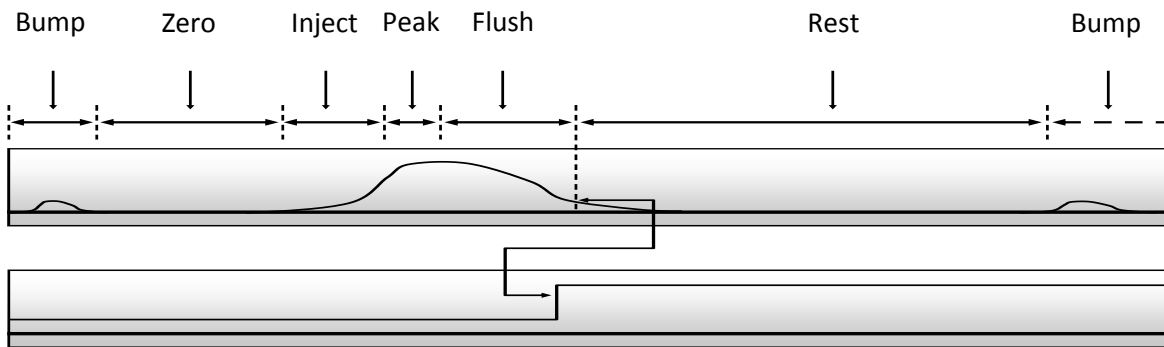

Figure 6-2 Measurement Sequence

GASMAX CX GAS SENSOR

The GASMAX CX gas sensor provides real-time gas concentration measurement data to the GDS-68SXP. During power-up, sensor information is uploaded from the sensor to the GASMAX CX and is then transferred to the GDS-68SXP via an internal RS-485 serial interface. The GASMAX CX manages the sensor and applies amplification, filtering and temperature compensation to the sensor output.

SENSOR CONSIDERATIONS

The GDS-68SXP supports electrochemical sensors for hydrogen sulfide, mercaptan, tetrahydrothiophene, specific odorant blends and other gases. Each sensor contains a fixed amount of chemical electrolyte that reacts with the target gas to create free electrons that are amplified and measured. Once the electrolyte is depleted, sensor output will diminish, and the sensor must be replaced.

IMPORTANT: SENSORS ARE SUBJECT TO ACCELERATED DETERIORATION IF POWER IS NOT APPLIED WITHIN 3 MONTHS OF SHIPMENT FROM GDS CORP.

7 INSTALLATION

Proper installation is critical for reliable operation and accurate data. In general, install the GDS-68SXP Process / Odorant Monitor as close as practical to the source of the sample gas to minimize latency and ensure that fresh sample is available for each measurement cycle. Keep the unit away from high temperatures, strong electrical fields and sources of vibration.

INSTALLATION SAFETY PRECAUTIONS

- The GDS-68SXP is heavy and bulky. Use proper techniques when lifting and mounting the enclosure.
- Always use proper mounting hardware and make sure the GDS-68SXP is securely attached to a solid wall, bulkhead or mounting bracket before attempting to operate the device.
- If utilizing a local 110VAC to +24VDC supply, make sure a power cutoff switch is located within visual sight of the unit, or install and use a locking switch to ensure that power is not applied accidentally.

7.1 PHYSICAL MOUNTING GUIDELINES

When installing the GDS-68SXP Process / Odorant Monitor, make sure to allow at 6" clearance on the top and right side of the unit, and at least 18" clearance on the left side and below the unit for conduit connections, sample connections and drain connections.

Always mount the GDS-68SXP in a vertical position to ensure proper operation of flow switch and filter drains.

If mounted outdoors, ensure that all drains and vents have in-line filters or screens to keep dust and insects out of the tubing and sensor head.

If possible, mount the GDS-68SXP in such a way as to not allow direct sunlight to shine on the GDS-68SXP LCD screen or GASMAX CX LCD screen. Extended exposure to direct sunlight will damage the display components.

In excessively cold climates, GDS Corp recommends heat-trace on incoming sample tubing and an enclosure heater to make sure that any moisture in the sample remains gaseous and does not freeze as it flows through the inlet tubing and internal components.

Always use recommended conduit and poured seals for signal and power wiring installation in hazardous areas. Consult local codes and regulations where appropriate.

When fabricating external tubing connections for sample inlet and filter drain outlets, never use straight connections as they can be difficult to remove once installed. Always include one or more 90° bends to make removal and replacement easier.

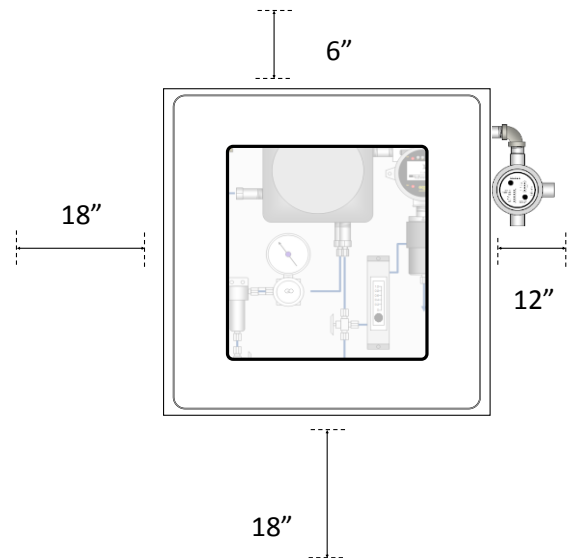

Use clear flexible tubing where possible on filter drain lines as this makes it easier to determine if moisture is present in the sample drain line.

7.2 POWER & SIGNAL CONNECTIONS

Power, analog and digital signal connections are located in the wiring junction box that extends out of the upper right-hand side of the GDS-68SXP. To access the power and MODBUS terminals, remove the cover of the wiring junction box. An LED indicator will illuminate if DC power is applied to the unit.

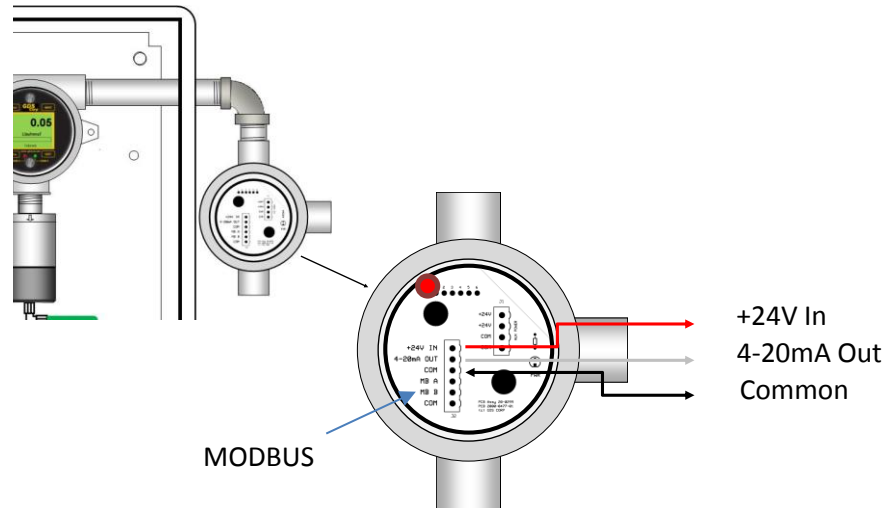

Figure 7-1 GDS-68SXP Wiring Junction Box

DC POWER / ANALOG OUTPUT

Connect a source of +24VDC, $\pm 5\%$ power to Pin 1 (+24V IN) and Pin 3 (COM) as shown above. The non-isolated 4-20mA current loop source output is available at Pin 2 (4-20mA).

Always provide a DC power shutoff switch in the vicinity of the GDS-68SXP for use during startup, sensor replacement and maintenance and troubleshooting. GDS Corp recommends a 1A slow-blow fuse in series with the DC supply to provide the necessary circuit protection.

Possible values for the analog output current loop include the standard 4mA to 20mA range as well as values between 4mA and 0mA that indicate FAULT conditions. Make sure that any device that monitors the 4-20mA single is capable of measuring and responding to discrete values less than 4.0 mA.

MODBUS INTERFACE

The GDS-68SXP provides a two-wire serial RS-485 RTU interface (“A”, “B”) that allows a remote MODBUS serial master to request data from the Controller’s MODBUS database. Connect a two-wire MODBUS Master device to the GDS-68SXP using Pin 4 (“A”) and Pin 5 (“B”). A second parallel Common is available for MODBUS wiring (Pin 6). A complete description of the internal MODBUS database is shown in Chapter 13.

7.3 AC HEATER (OPTIONAL)

The 200-watt AC-powered heater is recommended for outdoor applications where ambient temperatures may fall below freezing for extended periods of time. Access to the heater wiring is via a separate $\frac{3}{4}$ " NPT fitting on the bottom of the heater junction box. Note that all high voltage AC wiring must be kept separate from lower voltage DC and signal lines.

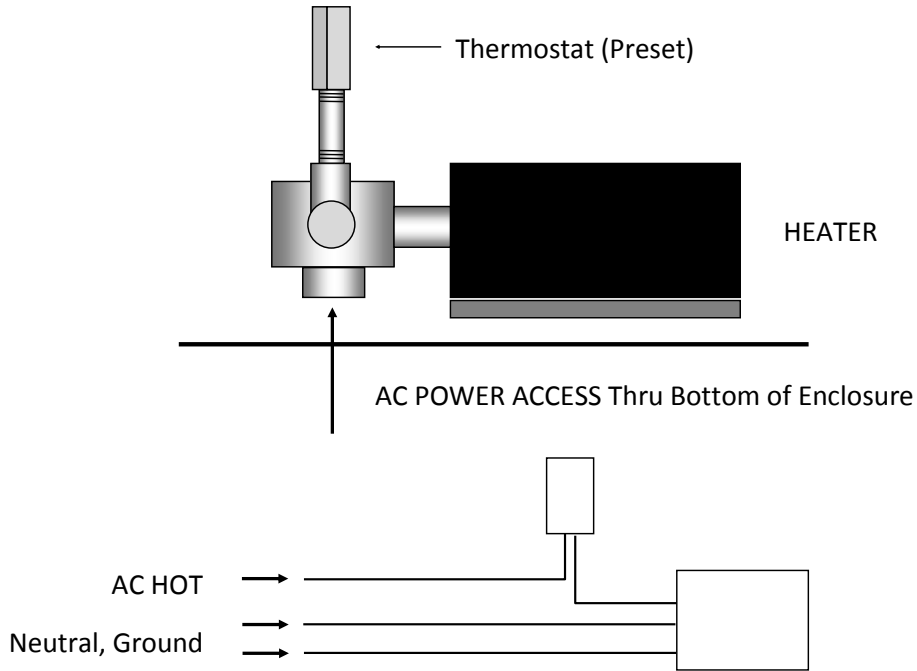

Figure 7-2: 200W AC Heater Wiring

Local codes and good wiring practice require an AC shutoff within sight of the heater assembly for maintenance and testing. **IMPORTANT: Keep all electrical fittings tight while circuits are alive.**

7.4 GAS, AIR & EXHAUST CONNECTIONS

PURGE AIR INLET

Purge air should be drawn from a source of ambient air that is clean and free of significant levels of mercaptan or other toxic gases.

In most cases it is desirable to draw purge air from inside the enclosure. This generally ensures that the air is clean and warm, and that liquid moisture or ice cannot collect on the inlet. This has a side benefit of providing an early warning of any gas leakage into the enclosure by elevating the sensor zero, resulting in a Zero Offset warning condition.

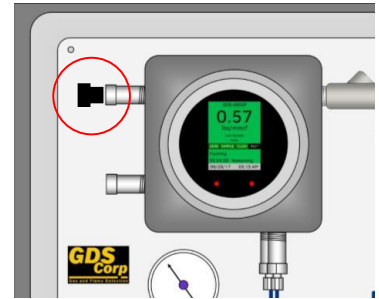

A purge air inlet filter with replaceable element is included with the GDS-68SXP.

If the local area may contain residual gas, GDS Corp recommends placing an external Purge Air inlet in a location that is free from background gas and protected from heavy rains, water spray and snow or ice. Be sure to cover all openings with screens to prevent insects from entering.

SAMPLE INLET

The length of time it takes for gas to flow from the sample source to the GDS-68SXP inlet should not exceed 30 seconds to ensure that “fresh” sample is available at the beginning of each measurement cycle. For ¼” OD stainless steel tubing and sample flow rates of approximately 0.5 liters per minute, the maximum length should be no more than 60 feet (~20 m). Smaller diameter tubing will allow longer runs but may be subject to clogging if the sample contains particulate or moisture. Larger diameter tubing should be avoided due to the internal volume of entrained gas.

GDS Corp recommends installing a low-volume high-pressure regulator / filter at the point where the gas is extracted from the pipeline. This will minimize the pressure in the line between the gas extraction point and GDS-68SXP and further reduce the total volume of gas stored in the sample line.

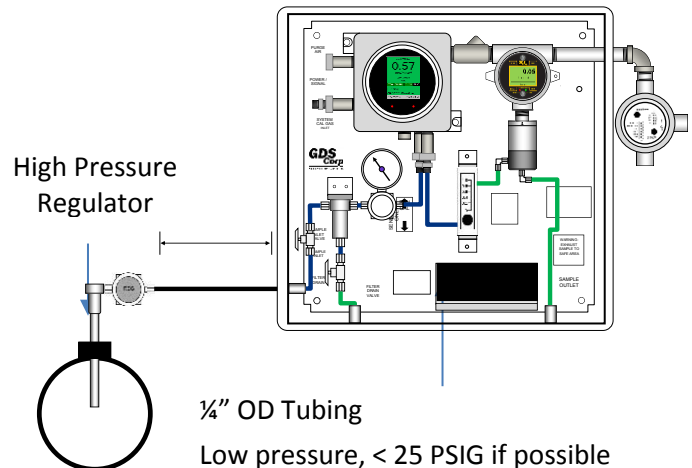

Be sure to connect the inlet tubing to a line that contains fresh gas. In cases where the 68SXP has been connected to stub headers, the values read by the GDS-68SXP may be up to 6-8 hours ‘behind’ the actual value measured in the main pipeline.

CALIBRATION GAS INLET

A dedicated Calibration Gas Port Inlet is provided on the lower left side of the XP enclosure. Use a DEMAND FLOW REGULATOR when connecting a calibration gas cylinder. Calibration gas for System Calibration Cycles and Gas Sensor Calibration must be connected to this port and calibration gas is drawn into the unit by the air pump.

IMPORTANT: DO NOT APPLY PRESSURIZED CALIBRATION GAS TO THE CAL GAS INPUT. USE A DEMAND FLOW REGULATOR OR GAS SAMPLING BAG.

FILTER DRAIN & FILTER BYPASS

All GDS-68SXP configurations include a coalescing filter with stainless steel drain valve. The drain valve should be opened periodically to release any built-up liquid that may have become trapped inside the filter. Conversely, the filter drain valve may be left 'cracked open' to allow moisture (and sample gas) to escape.

NOTE: LEAVING THE FILTER DRAIN VALVE 'CRACKED' OPEN WILL ALLOW SAMPLE GAS TO FLOW FROM THE PICKUP POINT TO THE GDS-68SXP ON A CONTINUOUS BASIS, ENSURING THAT FRESH SAMPLE IS ALWAYS AVAILABLE AT THE BEGINNING OF EACH NEW MEASUREMENT CYCLE.

SAMPLE EXHAUST

It is very important that the sample exhaust be as short as possible. Changes in ambient pressure affects the output from all electrochemical sensors and allowing the sample to exhaust directly to atmosphere will minimize these affects. Long runs of tubing connected to the sample outlet may increase the backpressure inside the sensor flow cell and cause higher than normal readings. Typical odorant is a heavy gas and will tend to 'back up' inside sample exhaust lines that extend vertically for too great a distance.

IMPORTANT: DO NOT RESTRICT SAMPLE EXHAUST OUTLET. PRESSURE IN THE SAMPLE FLOW CELL MAY DAMAGE THE SENSOR AND WILL RESULT IN INCORRECT READINGS.

IMPORTANT: WHEN INSTALLING THE GDS-68SXP OUTDOORS, MAKE SURE SAMPLE EXHAUST IS PROTECTED BY A SCREEN OR FILTER TO KEEP INSECTS FROM ENTERING THE EXHAUST PORT AND NESTING IN THE SENSOR FLOW CELL.

DANGER: BE SURE EXHAUST GAS IS DIRECTED AWAY FROM PERSONNEL AND EQUIPMENT, ESPECIALLY SUMPS OR LOW-LYING AREAS WHERE GASES CAN BUILD UP OVER TIME.

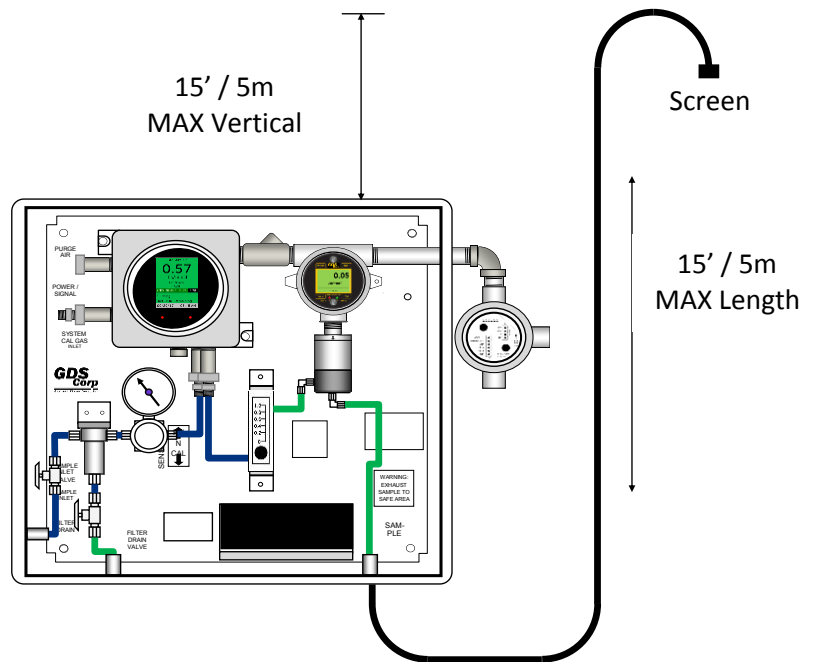

7.5 INSTALLATION RECOMMENDATIONS SUMMARY:

- Select an installation location that does not expose the unit to shock, vibration, moisture and damage
- Protect from dripping liquid or high-pressure water spray
- Mount the GDS-68SXP Process / Odorant Monitor vertically to ensure proper operation of the flow switch
- Do not mount the GDS-68SXP such that direct sunlight will shine on the GASMAX CX or System GDS-68SXP LCD display
- Make sure the power wiring size is appropriate for the DC load and distance
- Keep DC signal wiring and AC heater wiring in separate conduit runs
- Make sure sample conditioning is appropriate to the quality of the sample! The GDS-68SXP includes a 0.01 micro coalescing filter that will remove small amounts of moisture and particulate. Excessively wet or dirty samples may overwhelm the filter and damage the unit.
- Observe maximum inlet length recommendations
- Always provide an independent sample exhaust line; do NOT combine filter drain, bypass drain and sample exhaust ports into a single manifold.
- Make sure that exhaust gas is directed away from personnel and vented to a safe area where exhaust gas can dissipate
- If mounting the unit outdoors, protect all exposed vents or intakes with screens or filters to keep insects, moisture or dirt from entering the device.
- Read the chapter on Startup before applying power to the unit for the first time!

8 STARTUP PROCEDURE

Before start-up, review Chapter 6 (“Theory of Operation”) for a basic understanding of the unit and Chapter 9 (“GDS-68SXP User Interface”) for an understanding of the on-screen displays that will appear.

SEQ	PROCEDURE STEP	OK
1)	Mount the GDS-68SXP Process / Odorant Monitor to a pole or wall using the hardware supplied, Pole Mount Kit or user-supplied hardware. Face away from direct sunlight if possible. Connect the analog signal and/or MODBUS interface wiring.	
2)	Remove the yellow plug covers and direct the filter outlet and sample outlet to a safe location. If using tubing to direct the flow, run independent sample exhaust and filter / filter bypass exhaust lines (Do not combine these two into a single line!).	
3)	Close the sample inlet and filter drain valves.	
4)	Connect a source of line gas to the Sample Inlet Port. Keep the sample inlet pressure between 10 psig and 50 psig if possible.	
5)	Connect a cylinder of calibration gas with a DEMAND FLOW REGULATOR to the Cal Inlet Port using flexible tubing.	
6)	Apply power to the GDS-68SXP and watch for the display to illuminate and the GDS-68SXP screen to appear. Monitor the GDS-68SXP screen and watch for the Power OK message, Comm OK message, Sensor OK message and Warm-Up message. (NOTE: Warm-up will not commence until the sensor output is within +/-10% of zero)	
7)	With the pump running, set the Purge Air flow to between 0.5 and 0.7 LPM by adjusting the valve on the Flow Meter. Do NOT adjust the flow meter after this step!	
8)	Enter the Diagnostics Menu. Set the Air Pump to “OFF” and confirm that the Flow Switch status shows “NO FLOW”	
9)	Set the Sample Valve to “ON” and verify that the Flow Switch status shows “FLOW OK” and that sample gas is flowing through the flow meter.	
10)	Adjust the Inlet Regulator such that the sample flow rate is between 0.5 and 0.7 LPM. Allow the flow to continue until the gas sensor shows a stable value, approximately three minutes. Set the Sample Valve to “OFF” and the Air Pump to “ON” to purge the sensor for three minutes.	
11)	In the Diagnostics menu, set the Cal Gas Valve to “ON” and verify that the flow switch shows “FLOW OK” and that cal gas is flowing. Set the Cal Valve to “OFF” and exit the Diagnostics Menu.	
12)	Enter the System Menu and program the desired Initial Delay and Sequence Interval before Warm-Up is complete. Initial startup is now complete. See Chapter 11 for Calibration Setup Procedure.	

9 GDS-68SXP USER INTERFACE

The primary user interface for the GDS-68SXP Process / Odorant Monitor is in the left-hand gray explosion proof enclosure. The interface consists of a 320x240 full color LCD screen and four magnetic switches surrounding the display. To activate the magnetic switches, open the explosion proof cover and place a magnetic wand close to the switch or use the IOS application to activate functions via wireless communications.

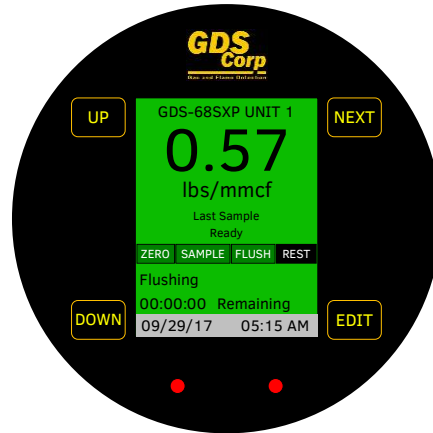

Figure 9-1 GDS-68SXP User Interface

The user interface screen gives a snapshot of the unit’s operational status and provides the following real-time information:

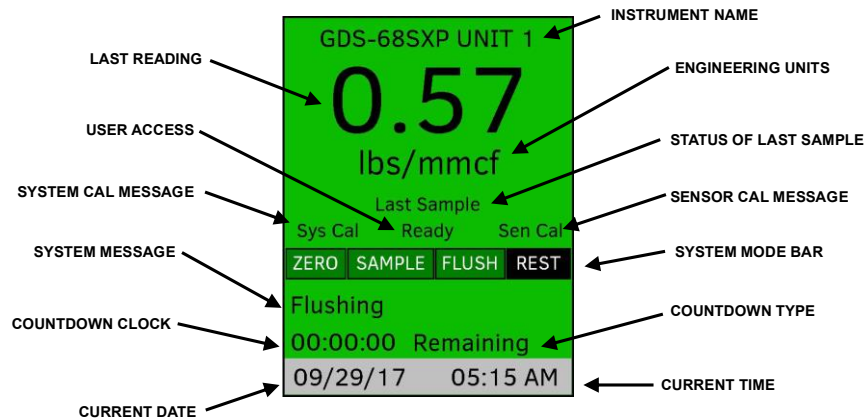

Figure 9-2 GDS-68SXP Main Screen

Instrument Name: A user-programmable 16-character text name assigned to this unit. The Instrument Name can be entered in the System Setup menu.

Last Reading: The most recent calibrated odorant measurement reading. A negative number implies one or more errors occurred during the measurement cycle.

Engineering Units: The current sensor’s Engineering Units. This can be “lbs/mmcF”, “mg/m3”, “ppm” or other. This information is retrieved from the GASMAX sensor and cannot be changed.

Status of Last Sample: Shows the date and time of the last successful reading, or an error warning if the last sample did not complete successfully.

User Access: If “Ready”, the user can immediately initiate a measurement cycle or calibration cycle. If “Busy” these operations are temporarily disabled because of proximity to previous measurement cycles.

System and Sensor Cal Message: Indicates whether System Calibration or Sensor Calibration are required. If CAL ONCE is selected, message will report “Cal Nxt” to indicate next cycle is calibration cycle.

System Mode Bar: Shows the status of the GDS-68SXP measurement cycle (“Zero”, “Sample”, “Flush”, “Rest”).

System Message: Additional information regarding measurement status or errors.

Countdown Clock: Shows time until next event, either completion of a current measurement cycle or time remaining until the start of the next measurement cycle.

Countdown Type: If showing “Remaining” then the countdown clock shows a fixed time to next event; if showing “Until Timeout”, countdown clock displays maximum time remaining to complete the current task (measuring zero, measuring gas, flushing sensor, etc.) before a timeout error is recorded.

Current Date: Internal clock date. This can be programmed in the Tech Settings menu or via the wireless app.

Current Time: Internal clock time. This can be programmed in the Tech Settings menu or via the wireless app.

The top panel above the System Mode Bar doubles as an alarm indicator. Green = no alarm, Yellow = Alarm 1 active, Red = Alarm 2 active, Orange = Alarm 3 active.

The bottom panel containing the current time and date doubles as a wireless connection indicator. If an iOS client application is connected to the GDS-68SXP, the panel will turn BLUE.

Pressing the NEXT key when the Main Screen is showing will bring up the Reading Screen that shows the time, date and value for the last 8 readings:

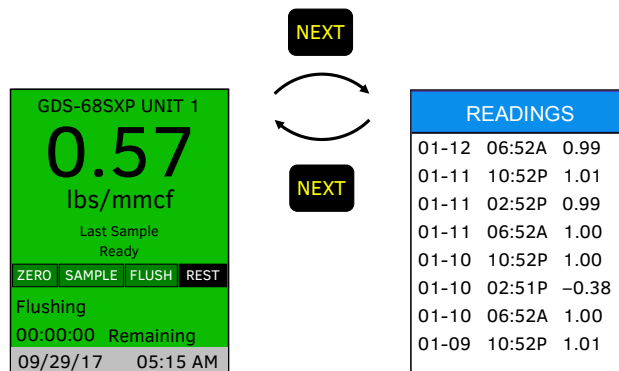

Figure 9-3 Last Readings Screen

Repeatedly pressing the UP key when the Main Screen is showing will cycle through the Quick Menus: Last Sample Screen, Last Cal Screen, System Status 1 Screen and System Status 2 Screen. This allows a technician to view important system settings without having to enter the Main Menu and risk accidentally changing a setting.

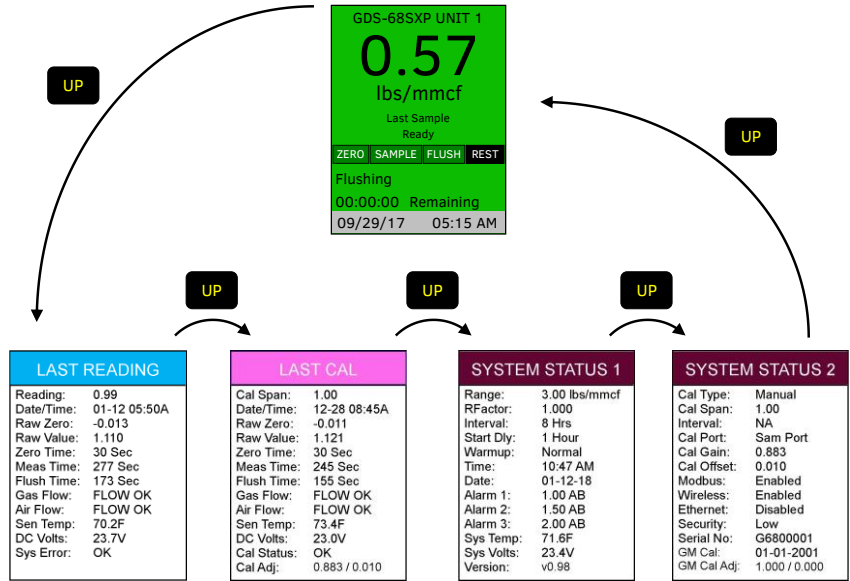

Figure 9-4 System Status Screens

Pressing the EDIT key when the Main Screen is showing brings up the Main Menu:

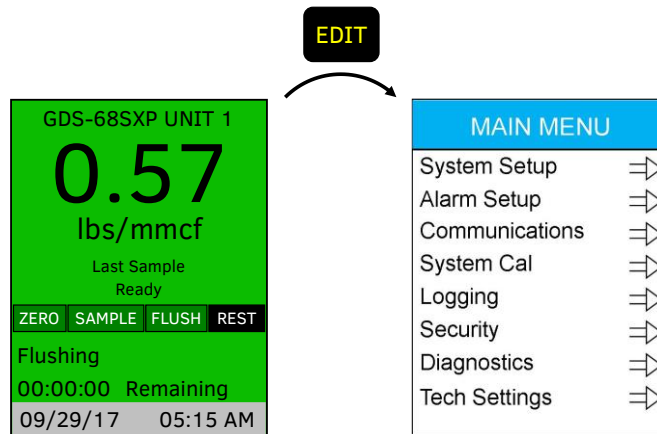

Figure 9-5 Main Menu Access

Once in the Main Menu, selecting an entry and pressing EDIT will provide access to all system settings and parameters:

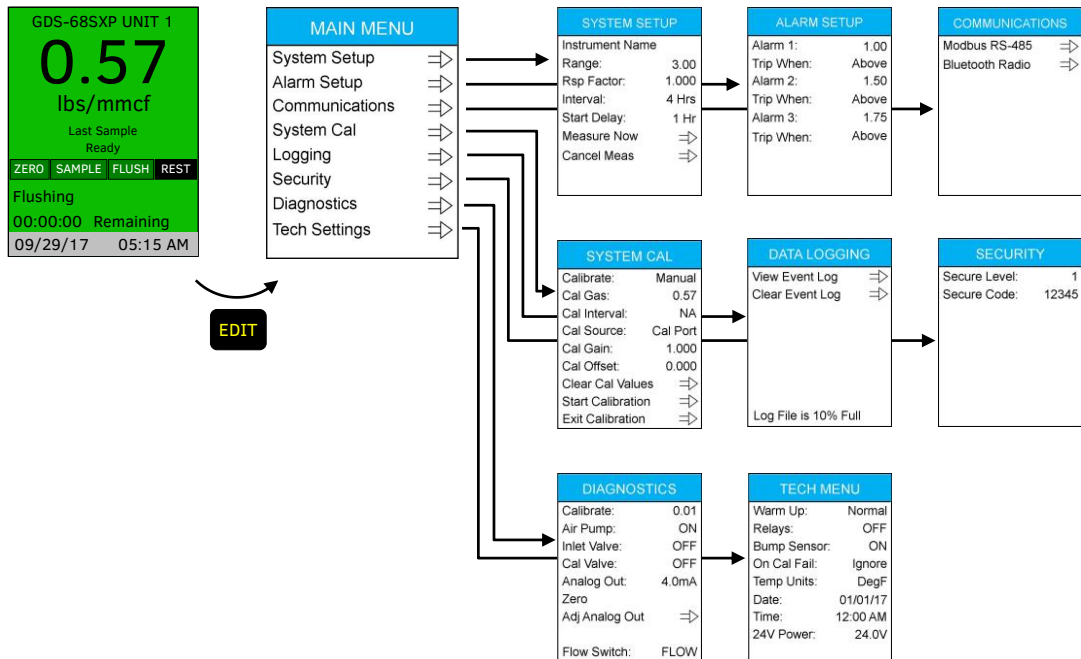

Figure 9-6 Main Menu Structure

Main Menu items include all options necessary to program and operate the GDS-68SXP odorant monitor. A complete description of all menu items and choices is shown in the chapter on GDS-68SXP User Menus.

10 GASMAX CX USER INTERFACE

The GASMAX CX gas monitor includes the electrochemical sensor element (“sensor”) and the electronics and processing necessary to generate calibrated, temperature-compensated gas concentration data used by the GDS-68SXP.

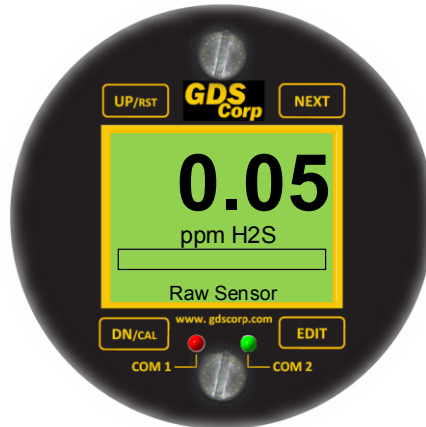

Figure 10-1 GASMAX CX Display

There are four magnetic switches on the face of the GASMAX CX, arranged in a quadrant around the LCD display. Starting in the upper left and proceeding clockwise these are labeled UP, NEXT, EDIT and DN/CAL. To activate, or “press” a magnetic switch, swipe the magnet near the switch. For the balance of this manual, the term “press” will be used to describe activation of any key via the magnetic wand.

Below the LCD display, two LEDs monitor the MODBUS RS-485 interface. Flashing indicates sent or received data and should always be present.

The **EDIT** key activates the USER MENU mode. During USER MENU mode, the UP, DN and NEXT keys are used to select and confirm menu entries. The USER MENU allows the operator to view the channel parameters and change certain system settings.

Pressing the **DOWN/CAL** key, followed by the EDIT key, initiates Gas Sensor Calibration mode. For a detailed description of Gas Sensor calibration, see Chapter 11.

Pressing the **NEXT** key momentarily causes the GDS-68XP display to sequence display screens between the Engineering Units display (see above) and 30-Minute Graph display.

NOTE: MOST SETTINGS IN THE GASMAX CX ARE UPLOADED FROM THE SENSOR OR ARE PRESET BY GDS CORP AND SHOULD NOT BE MODIFIED. USE CAUTION WHEN MAKING CHANGES, AS INCORRECT SETTINGS MY CAUSE THE GDS-68SXP TO MALFUNCTION

11 CALIBRATION OVERVIEW

Calibration is critically important to ensure correct and accurate operation of the GDS-68SXP Odorant Monitor. There are two steps necessary to calibrate a GDS-68SXP: **System Calibration** and **Gas Sensor Calibration**.

System Calibration is an automated measurement cycle that uses reference Span Gas to calibrate the end-to-end system response. System Calibration cycles can be performed manually or can be programmed to occur automatically on a daily, weekly or monthly basis.

Gas Sensor Calibration uses the semi-automated calibration procedure in the GASMAX to ensure that the sensor's response to gas is within designated limits. Gas Sensor calibration should be done periodically (every 90 to 180 days).

IMPORTANT – ALWAYS RUN A GAS SENSOR CALIBRATION AND A SYSTEM CALIBRATION **AFTER** INSTALLATION OR **AFTER** THE SENSOR ELEMENT IS REPLACED.

11.1 SPAN GAS

The best source of calibration span gas is a fresh cylinder containing a mixture of target gas / odorant and methane that replicates the expected gas sample. GDS Corp has several analytical laboratories that are capable of manufacturing accurate cylinders of gas / odorant mixture.

An alternative to custom mixtures is to use a cylinder containing pure tert-butyl mercaptan, isopropyl mercaptan or tetrahydrothiophene in methane and apply an appropriate conversion factor.

Finally, if no gas cylinder is available and the gas stream contains a known amount of target gas / odorant, the GDS-68SXP can be calibrated 'to the stream'.

11.2 ZERO GAS

Before each measurement cycle, the GDS-68SXP samples the background ambient air to determine the resting value for the sensor. This process assumes that ambient air contains very low levels of odorant.

During gas sensor calibration, a cylinder of Zero Air (O_2/N_2) should be used in place of ambient air for maximum accuracy.

IMPORTANT – NEVER USE PURE METHANE FOR A ZERO REFERENCE SINCE OXYGEN IS NEEDED TO REFRESH THE SENSOR.

11.3 CONNECTING CALIBRATION GAS TO THE GDS-68SXP

If you have a Demand Flow Regulator: Connect the calibration gas cylinder to the Cal Gas inlet on the lower left side of the Explosion Proof enclosure. The Demand Flow regulator will have a length of tubing that slips over the end of the calibration barb fitting on the cal gas inlet.

IMPORTANT – DO NOT CONNECT A STANDARD FIXED FLOW REGULATOR IN THIS MANNER.

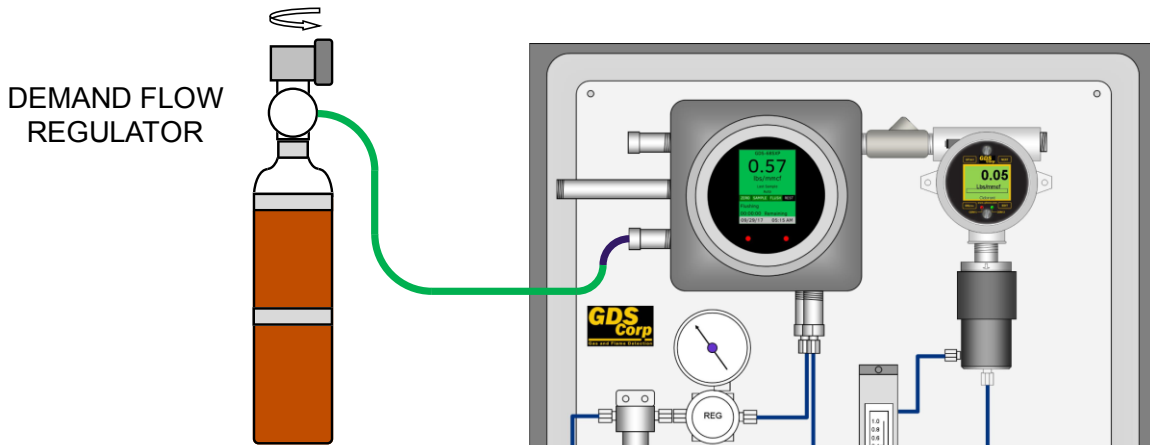

Figure 11-1 Calibration Setup (Demand Flow Regulator)

If you DO NOT have a Demand Flow Regulator: Connect the calibration gas cylinder to the Cal Gas inlet on the lower left side of the Explosion Proof enclosure in parallel with a “T” fitting connected to a sealed gas sample bag suitable for exposure to the gas or odorant used. Before calibration starts, open the fixed flow regulator and partially fill the gas sample bag with calibration gas. When the calibration cycle starts, the GDS-68SXP will draw calibration gas into the unit at 0.5 liters per minute. Monitor the bag and open the fixed flow regulator periodically to keep the bag partially filled during the calibration cycle.

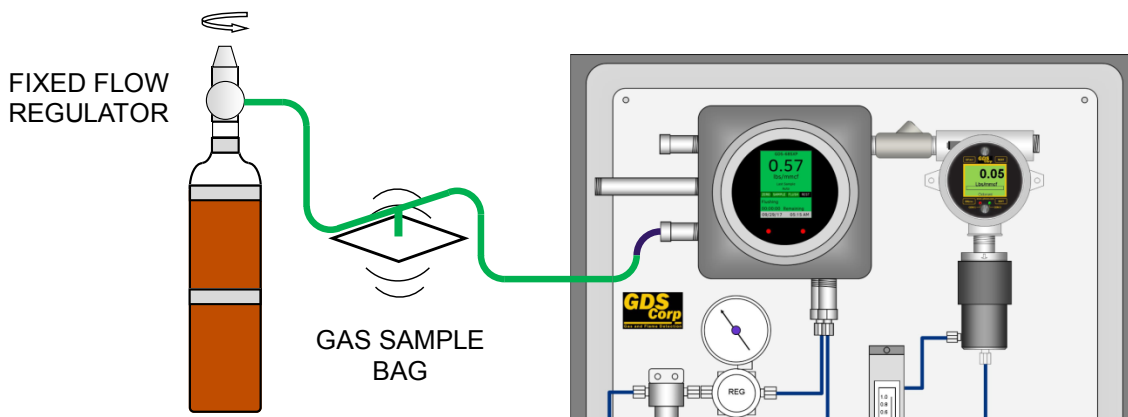
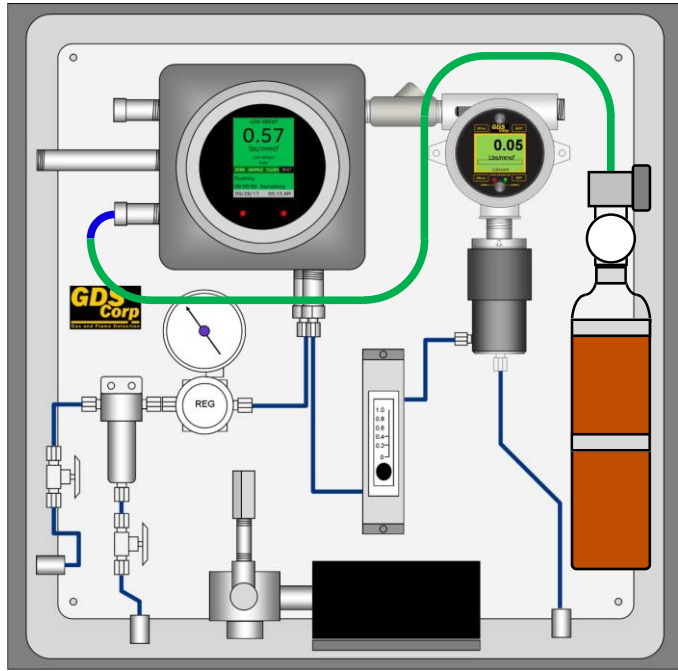

Figure 11-2: Calibration Setup (Fixed Flow Regulator)

For a permanent installation, GDS Corp recommends the Calibration Cylinder Mounting Kit (#20-0293). This kit contains a bracket that can hold 34L or 58L cylinders and a 3' length of flex tubing and all necessary hardware. The kit can be installed internally as shown or externally if needed.



DEMAND FLOW
REGULATOR
with
Low Pressure
Flex Tubing

Figure 11-3 Calibration Setup (Permanent DF Regulator)

If using user-supplied tubing, make certain that the tubing does not absorb odorant. GDS Corp recommends Tygon tubing for calibration.

IMPORTANT – DO NOT CONNECT A STANDARD FIXED FLOW REGULATOR IN THIS MANNER.

11.4 CAL SPAN VALUE

The cal span value should be set to the equivalent value of the calibration gas in the current engineering units setting. For example, 2.5 ppm tert-butyl mercaptan is equivalent to 0.57 lbs/mmcf.

Contact GDS Corp for more information on sensor types and cal span value calculations as referenced in publication *Sensor Selection for GDS-68SXP Natural Gas Odorant Monitors*, P/N 1200-0911.

12 SYSTEM CALIBRATION

System Calibration runs a complete measurement cycle, compares the results to preset target values and generates a system-level correction factor. System Calibration types can be MANUAL, ONCE or AUTO and the source of the calibration gas can be CAL PORT or GAS STREAM. These settings can be found on the Main Menu => System Cal Menu screen.

SYSTEM CALIBRATION (USER INITIATED)

Manual Calibration - When the Calibration Type is set to MANUAL, a calibration cycle will only run when initiated by the user during the REST mode. This can be done using a magnetic wand, via the IOS wireless application or via MODBUS. To manually start a system calibration cycle from the Main Screen, press the DOWN key followed by the EDIT key.

IMPORTANT - BEFORE STARTING A MANUAL CALIBRATION, BE SURE TO SELECT THE **CAL PORT** OR **GAS STREAM** INPUT SOURCE IN THE SYSTEM CAL MENU.

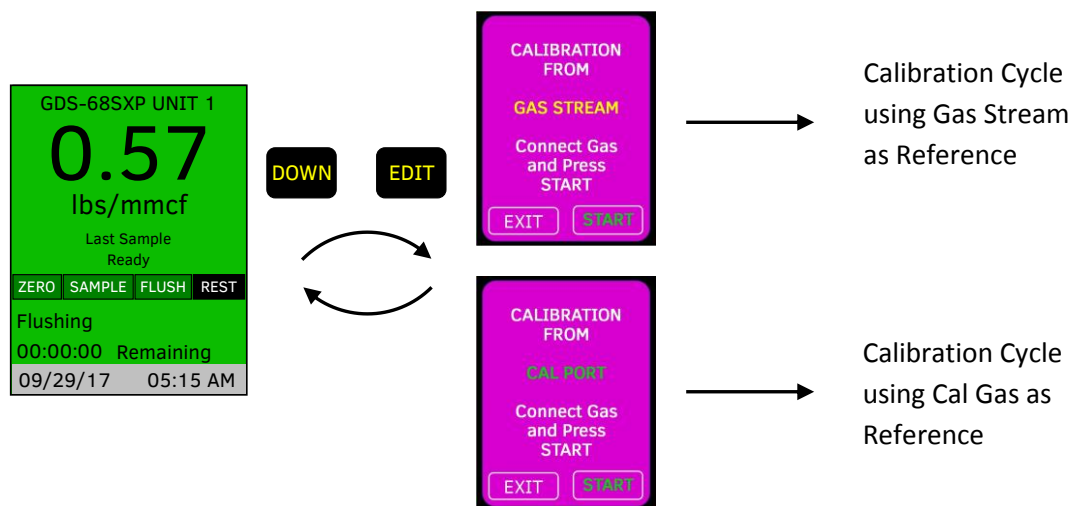

Figure 12-1 Manual System Calibration

Once started, a system calibration cycle will proceed without any additional input from the user. If the Cal cycle is successful, a Cal Success screen will appear, otherwise a Cal Fail screen will appear.

If the GDS-68SXP has just completed a measurement cycle, the system status will show BUSY and manual calibration will be temporarily disabled to allow the sensor time to recover from the exposure to target gas.

SYSTEM CALIBRATION (AUTOMATIC)

The GDS-68SXP can be programmed for two types of automatic calibration cycles: “Once” calibration and Automatic Calibration. Both cycles are identical; only the initiation process is different.

Calibration “Once” - When the Calibration Type is set to “Once”, a calibration cycle will occur *in place of* the next measurement cycle.

When choosing “Once”, be sure to select the desired calibration gas source. “Once” calibration can accept gas input from either the Cal Port or Gas Stream. Calibration Type reverts to MANUAL when complete.

Automatic Calibration - When the Calibration Type is set to Auto, the GDS-68SXP will run calibration cycles in place of measurement cycles on time intervals programmed in the System Cal Menu.

Automatic calibration intervals can be programmed for daily, weekly or monthly intervals. When the GDS-68SXP determines that an automatic calibration cycle is required, it will substitute a calibration cycle in place of the next measurement cycle. As a result, the output value shown on the display and indicated on the analog and MODBUS outputs won’t change until the measurement cycle following the automatic calibration cycle is completed.

Automatic calibration requires a source of calibration gas be connected to the Cal Port.

UNATTENDED AUTOMATIC CALIBRATION FAILURE OPTIONS

Since an automatic calibration cycle may occur when no one is present, and may fail due to a bad sensor, lack of gas, or other reason, the GDS-68SXP offers three ways to have the outcome of the calibration cycle affect the continued operation of the unit: “Ignore”, “Fail” and “Notify”. This setting is found in the Technicians menu on the GDS-68SXP.

“Ignore” means that the result of the failed calibration is ignored and calibration values from the last good calibration remain in effect.

“Fail” means that the output goes into CAL FAULT mode on both the 4-20mA output and MODBUS output.

“Notify” means that during the beginning of each measurement cycle, the 4-20mA output drops to 0mA (-25% of scale) for 15 seconds before returning to its previous value. This setting is useful if the only output being monitored is the 4-20mA analog value.

13 SYSTEM CALIBRATION PROCEDURE (CAL GAS)

To perform a **System Calibration** using a cylinder of calibration gas, follow the steps below.

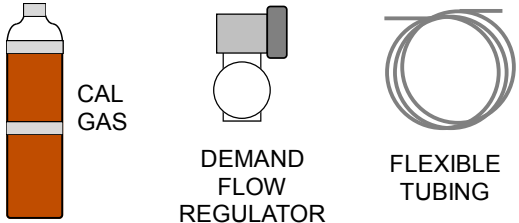
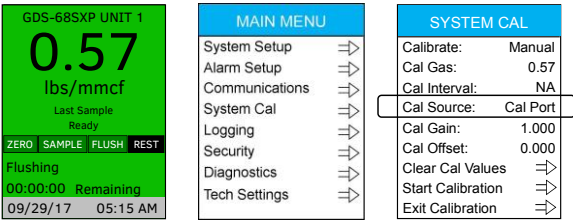
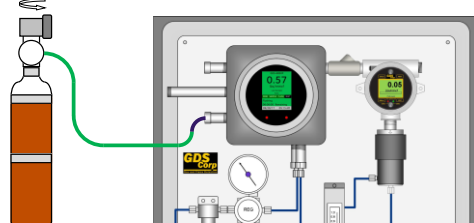
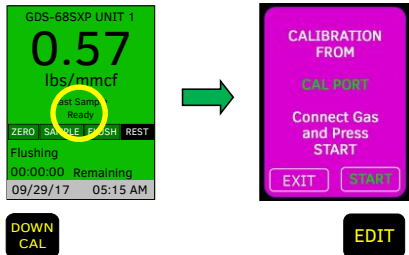
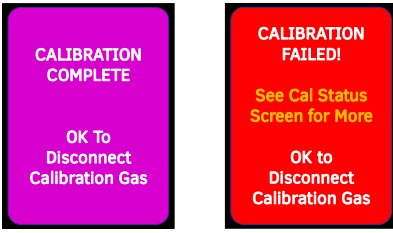
	PROCEDURE	
1	<p>Obtain a cylinder of CALIBRATION GAS (odorant + methane balance), a matching DEMAND FLOW REGULATOR and a length of FLEXIBLE TUBING.</p> <p>Check the use-by date on the cal gas cylinder to make sure it has not expired.</p>	
2	<p>Enter the SYSTEM CAL menu and verify that the Cal Source is set to CAL PORT.</p> <p>(From the Main Screen, press EDIT to access the Main Menu. On the Main Menu, select System Cal and press EDIT to view System Cal menu)</p>	
3	<p>Attach the cylinder of CAL GAS to the Cal Inlet Port using a DEMAND FLOW regulator. Open the regulator valve by turning the top knob 90 degrees in either direction.</p>	
4	<p>If USER ACCESS shows “READY”, use the magnetic wand to press the DN/CAL button to initiate a System Calibration cycle. Calibration can also be initiated using the <i>GDS Connect</i> iOS app or by sending a command via MODBUS.</p>	
	<p>The remainder of the System Calibration cycle will run automatically and show a CAL COMPLETE or CAL FAIL message. Once the cycle is complete, the unit will enter a cal delay and the USER ACCESS message will show “BUSY”.</p>	

14 SYSTEM CALIBRATION PROCEDURE (STREAM)

To perform a System Calibration USING THE SAMPLE STREAM, follow the steps below.

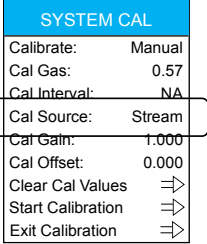
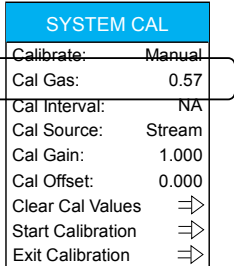
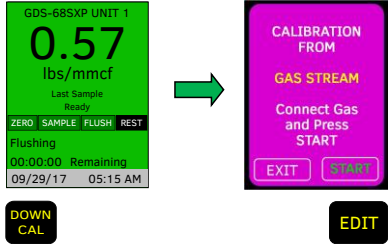
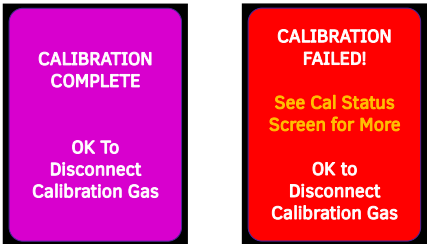
	PROCEDURE STEP	
1	<p>Enter the SYSEM CAL menu and verify that the Cal Source is set to Stream.</p> <p>Note: Calibration to the Stream can only be done in Manual or Once mode. Automatic or repeating calibration must use a cylinder of calibration gas.</p>	 <p>SYSTEM CAL</p> <ul style="list-style-type: none"> Calibrate: Manual Cal Gas: 0.57 Cal Interval: NA Cal Source: Stream Cal Gain: 1.000 Cal Offset: 0.000 Clear Cal Values ⇒ Start Calibration ⇒ Exit Calibration ⇒
2	<p>Calculate, measure or estimate the concentration level of odorant in the stream and calculate the expected value. Enter that value as the Cal Span Value in the SYSTEM CAL menu.</p>	 <p>SYSTEM CAL</p> <ul style="list-style-type: none"> Calibrate: Manual Cal Gas: 0.57 Cal Interval: NA Cal Source: Stream Cal Gain: 1.000 Cal Offset: 0.000 Clear Cal Values ⇒ Start Calibration ⇒ Exit Calibration ⇒
3	<p>If USER ACCESS shows “READY”, use the magnetic wand to press the DN/CAL button followed by the EDIT button to initiate a System Calibration cycle. Calibration can also be initiated using the <i>GDS Connect</i> iOS app or by sending a command via MODBUS.</p>	 <p>The diagram shows a green display screen on the left with a large '0.57 lbs/mmcF' reading and a 'DOWN CAL' button below it. An arrow points to a purple 'CALIBRATION FROM GAS STREAM' screen on the right, which has an 'EDIT' button below it.</p>
4	<p>The remainder of the System Calibration cycle will run automatically and show a CAL COMPLETE or CAL FAIL message. Once the calibration cycle is complete, the unit will enter a fifteen-minute cal delay and the USER ACCESS message will show “BUSY”.</p>	 <p>Two vertical screens are shown side-by-side. The left one is purple and says 'CALIBRATION COMPLETE' and 'OK To Disconnect Calibration Gas'. The right one is red and says 'CALIBRATION FAILED!' and 'See Cal Status Screen for More' and 'OK to Disconnect Calibration Gas'.</p>

15 GAS SENSOR CALIBRATION PROCEDURE

To perform a Gas Sensor Calibration, follow the steps below. Do not perform a Gas Sensor Calibration unless the GDS-68SXP Odorant Monitor is in REST MODE.

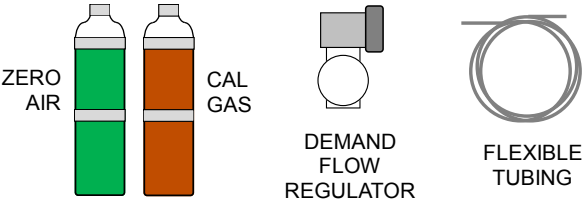
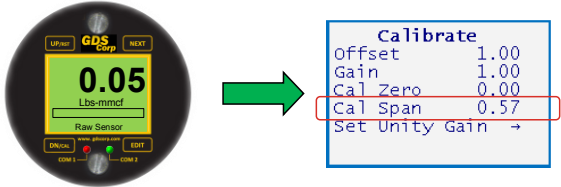
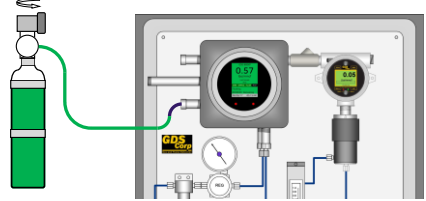
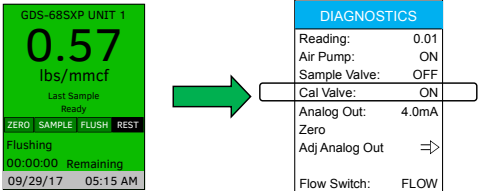
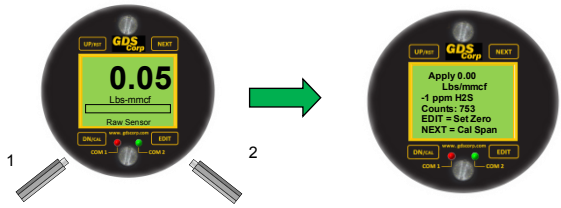
	PROCEDURE STEP	
1	Obtain a cylinder of ZERO AIR, a cylinder of CALIBRATION GAS (odorant + methane balance), a matching DEMAND FLOW regulator and a length of flexible tubing.	
2	Determine the appropriate setting for the GASMAX CX Cal Span Value as described earlier and load the value in the GASMAX CX -> XXXX menu. (Main Menu -> Channel Settings -> Channel 1 -> Calibrate Menu)	
3	Connect the ZERO AIR to the regulator and connect the regulator to the Cal Gas Inlet port. Open the regulator valve by turning the top knob 90 degrees in either direction.	
4	On the GDS-68SXP display, go to the SYSTEM MENU -> DIAGNOSTICS MENU and set the CAL VALVE to "ON". The Flow Switch should indicate "FLOW" and flow should be visible on the flow meter.	
5	Place the GASMAX CX into CAL MODE by using a magnetic wand to press the DN/CAL button and then the EDIT button ON THE GASMAX CX DISPLAY. The GASMAX CX display will show the "Apply Zero" message.	

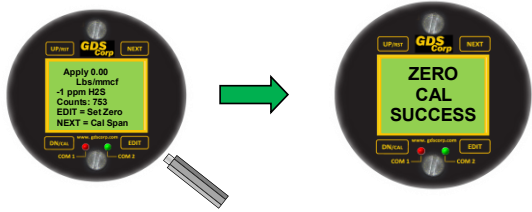
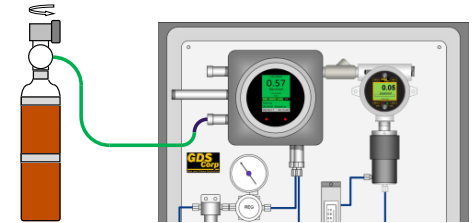
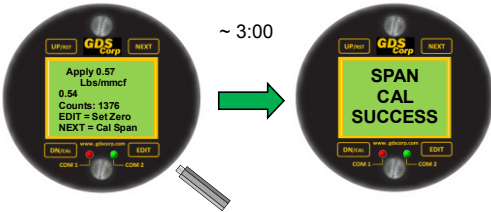
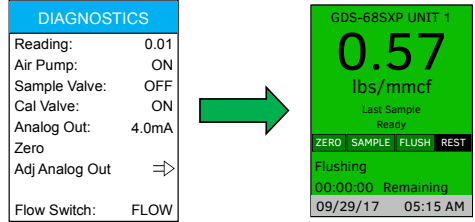
6	<p>Once the reading has stabilized, press the EDIT key on the GASMAX CX to store the zero value. If within limits, the GASMAX CX will show a “Zero Cal Successful” message followed by the “Apply Span” message. Zero calibration is now complete.</p>	
7	<p>Turn off the regulator and disconnect the cylinder of ZERO AIR. Attach the cylinder of CAL GAS and turn on the regulator. Confirm that gas is flowing as before. The GASMAX value will begin to increase.</p>	
8	<p>Once the reading has stabilized (~ 3 min), press the EDIT key on the GASMAX CX to store the span value. If the span is within limits, the GASMAX CX will display a “Span Cal Successful” message. Span calibration is now complete.</p>	
9	<p>Exit the GDS-68SXP DIAGNOSTICS MENU by pressing the NEXT key. This will close the Cal Gas valve and restart the purge air flow.</p>	
10	<p>Disconnect the gas cylinder and regulator. Gas sensor calibration is complete once the Cal Delay time expires.</p>	

16 MAINTENANCE

INSPECTIONS

Once setup and calibration is complete, further user intervention is not required and the GDS-68SXP will continue to take samples on intervals specified by the user.

The unit should be periodically inspected for the following: clogged or blocked air inlet or sample exhaust; moisture in the flow meter or flow switch; fault indication on the GDS-68SXP screen or GASMAX CX screen; excessive dirt inside the enclosure and other generally undesirable conditions.

Standard maintenance for the GDS-68SXP Process / Odorant Monitor consists of periodic checks on flow settings and sensor calibration. Each time a Gas Sensor calibration is completed, a new Sensor Life reading will appear that gives an approximate indication of the remaining sensitivity. Sensor Life is not necessarily linear and a rapid reduction in the sensor life reading can be due to temperature extremes, high levels of target gas, the presence of certain gases that 'poison' toxic sensors and other environmental factors.

INSPECTING THE INLET FILTER

The inlet filter should be inspected every six to 12 months. To inspect the inlet filter element, turn off the inlet valve and then open the filter drain valve to discharge gas remaining inside the filter. Using a wrench, remove the tubing connection between the bottom of the filter drain valve and bulkhead fitting. Unscrew the filter body and drain valve assembly and inspect the filter element for discoloration and moisture. Replace the filter element if necessary.

CHECKING FLOW LEVELS

Sample and air flow should always remain between 0.5 LPM to 0.75 LPM. While the exact value is not critical, if flow drops below 0.25 LPM there is a chance that the flow switch will indicate a loss of flow during a sample measurement or calibration cycle. .

To properly set the flow level: 1) with purge air flowing, adjust the FLOW METER valve so that the flow of purge air is approximately 0.5 LPM; then 2) enter the Diagnostics Menu and activate the Sample Valve. With sample gas flowing, 3) adjust the REGULATOR so that sample flow is approximately 0.5 LPM.

TESTING THE OPERATION OF INTERNAL COMPONENTS

The GDS-68SXP Diagnostics menu can be used to activate the Sample Valve, Cal Valve and Air Pump, and force the Analog Output and MODBUS output to predetermined values for diagnostics and signal level confirmation. The Diagnostics menu also shows the real-time status of the Flow Switch, and by turning the Air Pump on and off the user can confirm proper operation and ensure that it is not sticking open or closed.

SENSOR REPLACEMENT

If a sensor indicates FAULT, does not respond to gas or can no longer be calibrated, it should be replaced by following the procedure below:

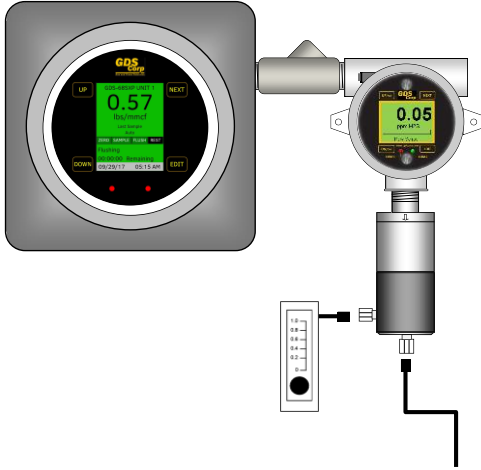

Step 1: Remove DC power from the unit

Step 2: Carefully disconnect the inlet and outlet connections on the sensor flow cell two adjustable wrenches.

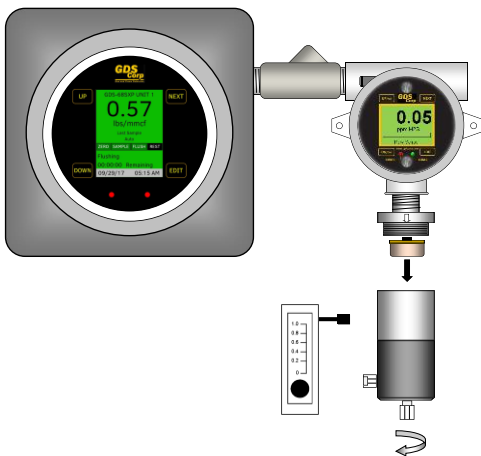

Step 3: Unscrew the flow cell + sensor head cover being careful not to dislodge the sensor element.

Step 4: Remove the old sensor by pulling straight down (do not unscrew sensor)

Step 5: Inspect the sensor head cover and sensor for any signs of moisture or damage.

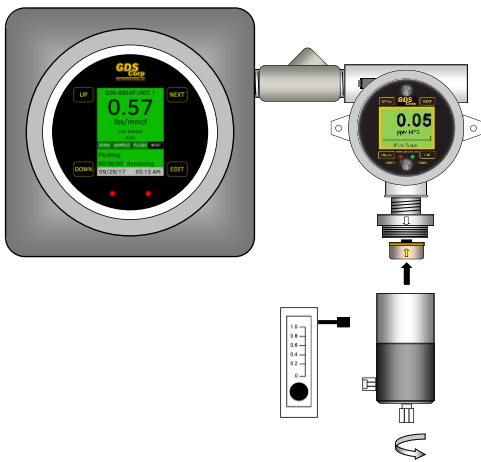

Step 6: Install the new sensor by aligning the arrow on the sensor label with the engraved arrow on the sensor head and pushing straight up.

Step 7: Reinstall the sensor head cover and flow cell being very careful not to dislodge sensor.

Step 8: Reconnect sample inlet and outlet tubing.

Step 9: Apply power to the unit and allow it to warm up for more than one hour.

Step 10: Perform the Gas Sensor calibration, wait 10 minutes and perform a System Calibration.

16.1 HARD FAULT CONDITIONS

The GDS-68SXP Process / Odorant Monitor monitors flow rates and sensor readings to detect problems. If a major fault occurs during a sample sequence, the 4-20mA and MODBUS outputs will indicate one the following unrecoverable / critical fault conditions. If no critical fault occurs, the display and outputs will track the measured value.

FLOWSWITCH FAULT Indicates that the flow switch did not drop out (possibly stuck “on”) during the ‘no-flow’ interval between the zero and gas measurements.

GAS FLOW FAULT Indicates that the flow switch measured more than 25 seconds of insufficient flow during the gas measurement cycle.

CALIBRATION FAULT – Indicates that a previous calibration failed if the “On Cal Fail” setting is set to “Fail”. If the “On Cal Fail” setting is set to “Ignore” or “Indicate” this fault will never occur.

AIR FLOW FAULT Indicates that the flow switch measured more than 25 seconds of insufficient flow during the zero or purge measurement cycle.

SENSOR FAULT – Indicates that the GASMAX CX indicated a Sensor Fault for at least 10 seconds at some point during the measurement cycle.

FAULT	REASON	% OF SCALE	OUTPUT (MA)	RANGE: 0-3.00	RANGE: 0-50.0
FLOWSWITCH FAULT	Flow switch did not drop out between zero and span measurement	-12.5%	2.0 MA	“-0.37”	“-6.2”
GAS FLOW FAULT	Insufficient flow of sample gas during gas measurement cycle	-15%	1.6 MA	“-0.45”	“-7.5”
CALIBRATION FAULT	Previous calibration failed (if enabled by user)	-17.5%	1.2 MA	“-0.52”	“-8.7”
AIR FLOW FAULT	Insufficient flow of purge air during zero and purge cycle	-20%	0.8 MA	“-0.60”	“-10.0”
SENSOR FAULT	GASMAX sensor FAULT during sample measurement cycle	-22.5%	0.4 MA	“-0.67”	“-11.2”

** Overrange Fault will immediately abort sample cycle and purge sensor to remove overrange gas from flowcell.*

16.2 WARNING CONDITIONS

The GDS-68SXP tracks a number of parameters during each measurement cycle and records any deviations in the event log and in the Status Flags associated with each measurement or calibration cycle. Warnings do NOT cause the output to go into fault but should be checked during maintenance to determine if the sensor may need to be replaced.

WARNING	REASON	% OF SCALE	OUTPUT (MA)
OFFSET WARNING	Zero value measured at beginning of cycle exceeds +/- 10% of scale (Recalibrate gas detector)	N/A	Normal
OVERRANGE WARNING	GASMAX reading exceeded 100% of full-scale during measurement cycle (Check span setting)	N/A	Normal
ZERO TIMEOUT WARNING	Zero measurement interval exceeded maximum allowed time interval (Check sensor)	N/A	Normal
MEASUREMENT TIMEOUT WARNING	Gas measurement interval exceeded maximum allowed time interval (Check sensor)	N/A	Normal
RECOVERY TIMEOUT WARNING	Recovery from measurement to 10% of scale exceeded maximum allowed time (Check sensor)	N/A	Normal

16.3 FAULT AND WARNING INDICATOR BITS

During each cycle, faults and warnings are recorded and displayed on the “Last Sample” and “Last Calibration” quick menu screens. Faults and warnings also create system events that are stored in the Flash memory event log. See Chapter 24 (System Events) for more information.

Sys Status is displayed on the “LAST READING” quick menu and is a summary of specific failures or warnings that occurred during the last measurement cycle.

Bit 0 = Sensor Fault	Bit 8 = Offset Warning
Bit 1 = Flow Switch Fault	Bit 9 = Overrange Warning
Bit 2 = Gas Flow Fault	Bit 10 = Zero Timeout Warning
Bit 3 = Air Flow Fault	Bit 11 = Sample Timeout Warning
Bit 4 = Reserved (0)	Bit 12 = Recovery Timeout Warning
Bit 5 = Reserved (0)	Bit 13 = GASMAX Warning
Bit 6 = Reserved (0)	Bit 14 = Reserved (0)
Bit 7 = Reserved (0)	Bit 15 = Reserved (“0”)

Cal Status is displayed on the “LAST CAL” quick menu and is a summary of specific failures that occurred during the last calibration cycle.

Bit 0 = Sensor Fault	Bit 8 = Offset Warning
Bit 1 = Flow Switch Fault	Bit 9 = Overrange Warning
Bit 2 = Gas Flow Fault	Bit 10 = Zero Timeout Warning
Bit 3 = Air Flow Fault	Bit 11 = Sample Timeout Warning
Bit 4 = Reserved (0)	Bit 12 = Recovery Timeout Warning
Bit 5 = Reserved (0)	Bit 13 = GASMAX Warning
Bit 6 = Cal Zero Calculation Fault	Bit 14 = Reserved (0)
Bit 7 = Cal Span Calculation Fault	Bit 15 = Reserved (“0”)

Note that a calibration fault will not cause the output to drop into the fault range unless the “On Cal Fail” settings is set to “Fail”.

16.4 COLD WEATHER OPERATION

The GDS-68SXP Process / Odorant Monitor is designed for accurate and reliable operation across a wide range of operating conditions. Once running, the GDS-68SXP generates enough heat to maintain operation down to 0°F ambient and below. However, if the unit has been powered off, care should be taken during startup to make sure the purge air pump temperature is above 32°F prior to the application of DC power. To reduce the possibility of pump damage, in extremely cold weather GDS Corp recommends the 200W AC heater be turned on for several hours prior to applying DC power to the system. In addition, if the unit is to be left unpowered during extremely cold weather, GDS Corp recommends removing the sensor and storing it in a temperature-controlled location.

16.5 RESTORE FACTORY SETTINGS PROCEDURE

If an operator needs to restore all configurable settings back to factory default, the GDS-68SXP includes a RESTORE FACTORY SETTINGS feature, sometimes referred to as “Cold Boot”.

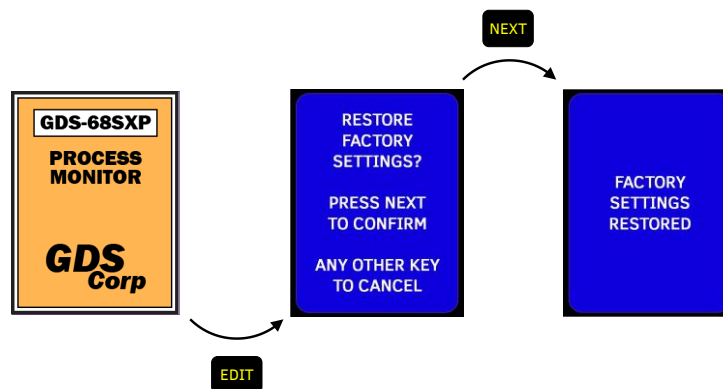

Figure 16-1 Restore Factory Settings Screens

To restore all settings to their default condition, HOLD a magnetic wand over the EDIT key when the splash screen appears after applying power. Once the Restore Factory Settings screen appears, HOLD the magnetic wand over the NEXT key until the Factory Settings Restored screen appears. The GDS-68SXP will reboot with all settings reset to factory defaults. Cold boot will not change the sensor range, serial number or certain other fixed settings.

Since the full-scale range, number of decimal points and engineering units are retrieved from the sensor installed in the GASMAX CX, those values will be automatically restored. Other settings, such as local alarm levels and external communications parameters may need to be reprogrammed.

NOTE – FACTORY COLD BOOT DOES NOT RESET THE SYSTEM SERIAL NUMBER, WIRELESS STATUS AND CERTAIN OTHER FACTORY-PROGRAMMED VARIABLES.

17 GDS-68SXP USER MENUS

SYSTEM SETUP MENU

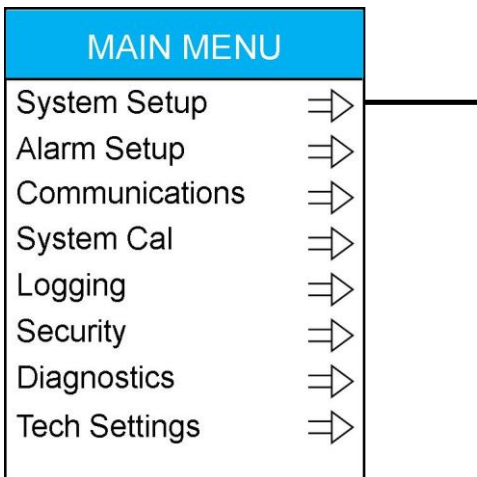

Instrument Name – A 16-character user-programmable text field used to provide a tag name or description of the GDS-68SXP

Range – The full-scale value of the currently installed sensor. This value is programmed into the sensor and cannot be changed

Response Factor – A floating point value that is used to adjust the displayed reading for various odorant combinations. For example, if an odorant were 80% TBM and 20% undetectable DMS, the Response Factor could be set to 1.250 to compensate for the lower reading.

Interval – The interval in hours between the start of each sample measurement cycle. Values are 15 min, 30 min, 1, 2, 3, 4, 8, 12 and 24 hours.

Start Delay – The interval between the end of Warm-Up and the beginning of the first measurement cycle or a specific time. Changing the Start Delay setting during the start delay will restart the timer to the new time.

Measure Now – Allows the user to initiate a measurement cycle.

Cancel Meas – Allows the user to abort a measurement cycle in progress.

ALARM SETUP MENU

MAIN MENU	
System Setup	⇒
Alarm Setup	⇒
Communications	⇒
System Cal	⇒
Logging	⇒
Security	⇒
Diagnostics	⇒
Tech Settings	⇒

ALARM SETUP	
Alarm 1:	1.00
Trip When:	Above
Alarm 2:	1.50
Trip When:	Above
Alarm 3:	1.75
Trip When:	Above

Alarm 1 – The Alarm 1 setpoint in the current engineering units.

Trip When – If trip ABOVE, alarm 1 is activated when the current reading is greater than the alarm 1 set point. If BELOW, alarm 1 is activated when the current reading is less than or equal to the alarm 1 set point.

Alarm 2 – The Alarm 2 setpoint in the current engineering units.

Trip When – If trip ABOVE, alarm 2 is activated when the current reading is greater than the alarm 2 set point. If BELOW, alarm 2 is activated when the current reading is less than or equal to the alarm 2 set point.

Alarm 3 – The Alarm 3 setpoint in the current engineering units.

Trip When – If trip ABOVE, alarm 3 is activated when the current reading is greater than the alarm 3 set point. If BELOW, alarm 3 is activated when the current reading is less than or equal to the alarm 3 set point.

COMMUNICATIONS MENU

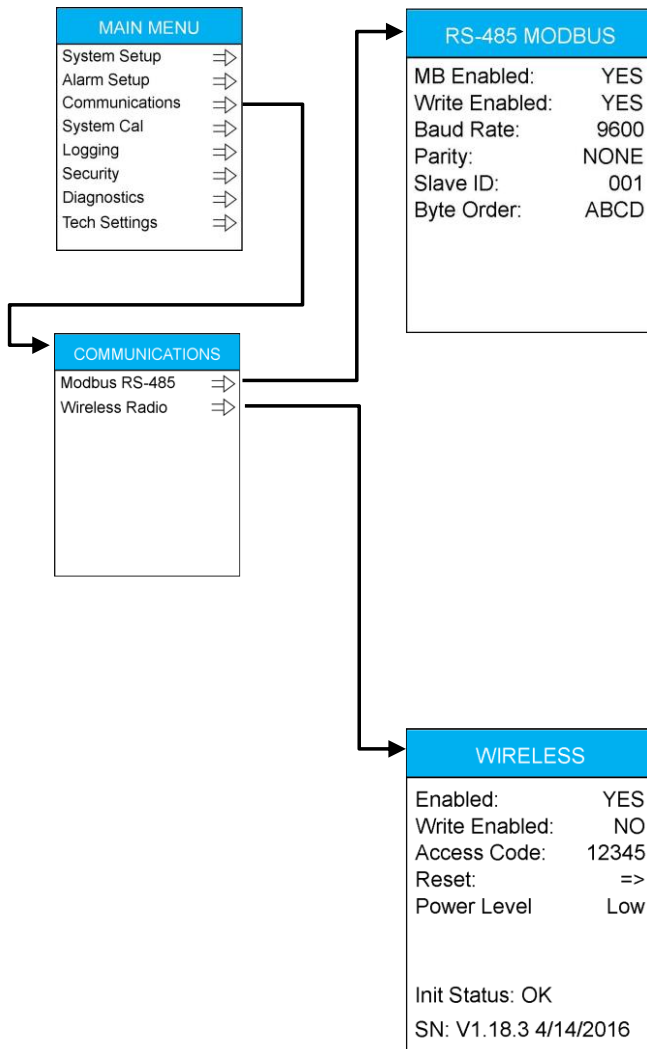

MB Enabled – Enables or disables MODBUS slave port. If NO, then absolutely no MODBUS data requests will be processed.

Write Enabled – Enables or disables writes to MODBUS slave port. If NO, slave port is read-only.

Baud Rate – Sets serial baud rate (Fixed at 9600)

Parity – Sets serial communications parity to EVEN, ODD or NONE (Fixed at None)

Slave ID – Sets MODBUS slave ID.

Byte Order – Sets order of byte transfers when reading 32-bit floating point numbers.

Enabled – Enables or disables wireless port. If NO, then absolutely no wireless data requests will be processed.

Write Enabled – Enables or disables writes to wireless port. If NO, the wireless interface is 100% read-only.

Access Code – Numeric code required by wireless app to enable access to data.
NOTE: Setting the code to “00000” eliminates the login requirement when connecting via IOS.

Reset – Performs hard reset. Recommended after changing Enable / Disable setting.

Power Level – Set the wireless transmit power. Recommended setting is “Low”.

Init Status – Information retrieved from the wireless chip. Useful for troubleshooting.

SYSTEM CAL MENU

MAIN MENU	
System Setup	⇒
Alarm Setup	⇒
Communications	⇒
System Cal	⇒
Logging	⇒
Security	⇒
Diagnostics	⇒
Tech Settings	⇒

SYSTEM CAL	
Calibrate:	Manual
Cal Gas:	0.57
Cal Interval:	NA
Cal Source:	Cal Port
Cal Gain:	1.000
Cal Offset:	0.000
Clear Cal Values	⇒
Start Calibration	⇒
Exit Calibration	⇒

Calibrate – System calibration type:

“**Manual**” – System calibration initiated by the user.

“**Once**” – System calibration automatically occurs in place of the next measurement cycle

“**Auto**” – System calibration occurs automatically on intervals set by Cal Interval

Cal Gas – The numeric value of the target calibration gas in the current engineering units.

Cal Interval – The length of time between automatic calibration cycles. If Cal Type is set to ONCE or MANUAL, the Cal interval is set to “NA”

Cal Source – The source of reference (“span”) gas used in a system calibration cycle.

“**Cal Port**” – During a calibration cycle, reference gas is drawn from the Cal Port fitting.

“**Gas Stream**” – During a calibration cycle, reference gas is drawn from the Sample Port fitting.

Cal Gain – The current Gain value used by the system to calibrate the output of measurement cycles.

Cal Offset – The current Offset value used by the system to calibrate the output of measurement cycles.

Clear Cal Values – Resets the Gain value to 1.000 and Offset value to 0.000.

Start Calibration – Allows the user to initiate a calibration cycle.

Exit Calibration – Allows the user to abort a calibration cycle in progress.

LOGGING MENU

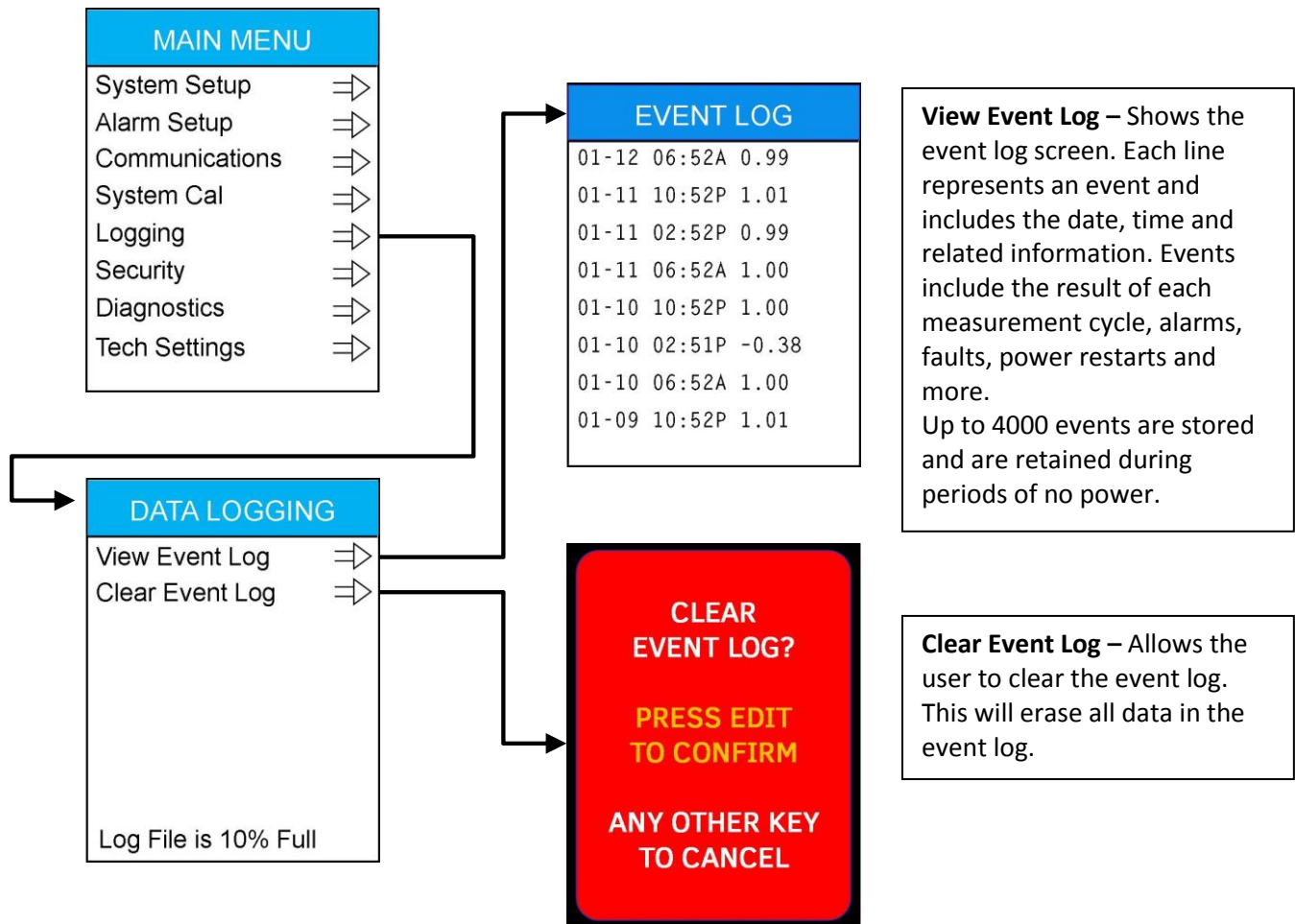

SECURITY MENU

MAIN MENU	
System Setup	⇒
Alarm Setup	⇒
Communications	⇒
System Cal	⇒
Logging	⇒
Security	⇒
Diagnostics	⇒
Tech Settings	⇒

SECURITY	
Secure Level:	1
Secure Code:	12345

Secure Level – The GDS-68SXP offers three levels of security:

“**Level 1**” – all menus are visible and modifiable. This is the default security level.

“**Level 2**” – Both MODBUS and wireless writes are disabled.

“**Level 3**” – All menu access is disabled without entering the Secure Code (see below). A user can initiate a calibration cycle using the DOWN / EDIT key sequence.

Secure Code – A user-programmable 5-digit code that must be entered to access any menu when the security level is set to “2” or “3”. See code entry details below.

ENTER CODE

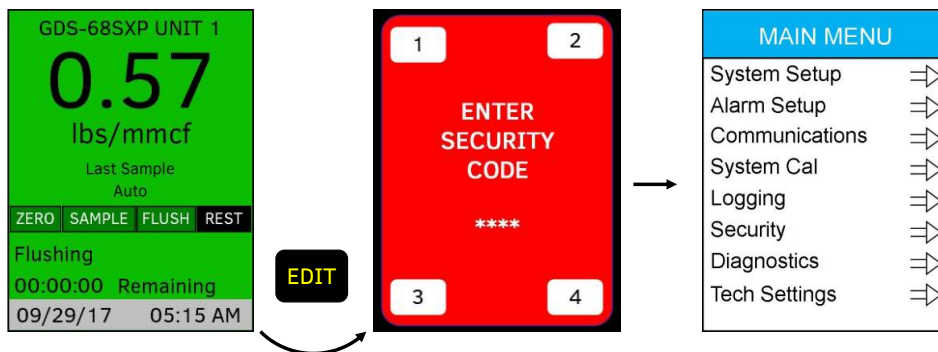

DIAGNOSTICS MENU

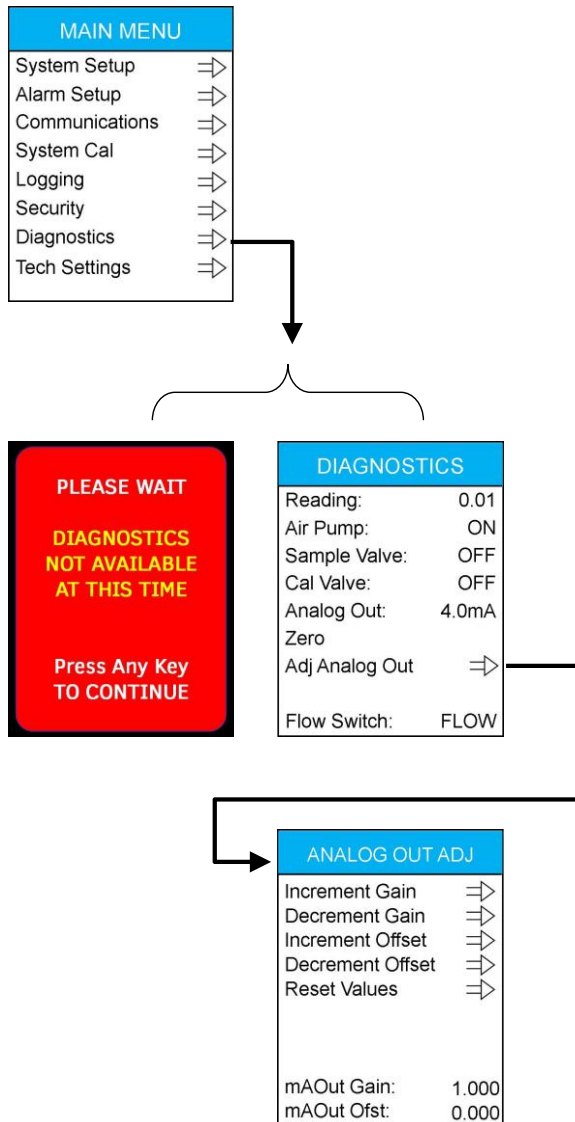

Reading – A live reading from the GASMAX CX. The reading shown should match that shown on the GASMAX CX display.

Air Pump – Allows the user to turn the Purge Air Pump ON or OFF. Turning the pump ON sets both the Sample and Cal valves OFF.

Sample Valve – Allows the user to activate the Sample Valve to allow stream gas to flow through the unit and into the GASMAX CX. Turning the Sample Valve ON automatically sets the Purge Air Pump to OFF.

Cal Valve – Allows the user to activate the Cal Valve to allow calibration gas (if connected) to flow through the unit and into the GASMAX CX. Turning the Cal Valve ON automatically sets the Purge Air Pump to OFF.

Analog Out – Allows the user to manually set the analog current output to discrete values. The output returns to its previous value after exiting the Diagnostics Menu.

“0.1mA” = GASMAX Fault

“0.4mA” = Zero Offset Fault

“0.8mA” = Air Flow Fault

“1.2mA” = Calibration Fault

“1.6mA” = Timeout Fault

“2.0mA” = Gas Flow Fault

“4mA” = 0% percent of scale

“8mA” = 25% of scale

“12mA” = 50% of scale

“16mA” = 75% of scale

“20mA” = 100% of scale

Adj Analog Out – Allows the user to ‘fine tune’ the analog 4-20mA output such that readings on remote devices can display identical values with that shown on the GDS-68SXP screen.

TECH SETTINGS MENU

MAIN MENU	
System Setup	⇒
Alarm Setup	⇒
Communications	⇒
System Cal	⇒
Logging	⇒
Security	⇒
Diagnostics	⇒
Tech Settings	⇒

TECH MENU	
Warm Up:	Normal
Relays:	OFF
Bump Sensor:	ON
On Cal Fail:	Ignore
Temp Units:	DegF
Date:	01/01/17
Time:	12:00 AM
24V Power:	24.0V

Warm Up – A fixed delay after power-up that gives the sensor time to stabilize.

“Short” – A fixed delay of 15 minutes.

“Normal” – A fixed delay of one hour. Ideal for most sensors.

“Long” – A fixed delay of 4 hours. Recommend for colder environments where it may take slightly longer for the sensor to stabilize.

“Extended” – A fixed delay of 12 hours; useful for certain types of biased sensors.

Changing the Warm-Up setting during warm up will reset the timer to the new setting value.

Relays – Reserved for future use

Bump Sensor – If enabled, opens the sample valve for a few seconds at the beginning of each cycle. Recommended for long (> 6 hr) intervals.

Cal Fail – Determines the system’s response to a failed *automatic* calibration cycle

“Ignore” – Calibration gain and offset from the most recent successful calibration and retained and used.

“Fail” – The analog output is immediately forced to the Cal Fail value.

“Notify” means that during the beginning of each measurement cycle, the 4-20mA output drops to 0mA (-25% of scale) for 15 seconds before returning to its previous value. This setting is useful if the only output being monitored is the 4-20mA analog value.

Temp Read – Display internal temperatures in Centigrade or Fahrenheit.

Date – Current date; view and program.

Time – Current time; view and program.

18 GASMAX CX USER MENUS

The GASMAX CX gas monitor used in the GDS-68SXP has a menu-driven user interface that allows the operator to review and adjust a wide range of settings. In the GDS-68SXP, channel 1 of the GASMAX CX measures the “raw sensor” gas level. Channel 2 is not used and is disabled. Do not enable channel 2 for any reason.

To access the Main Menu, activate the EDIT key with a magnetic wand.

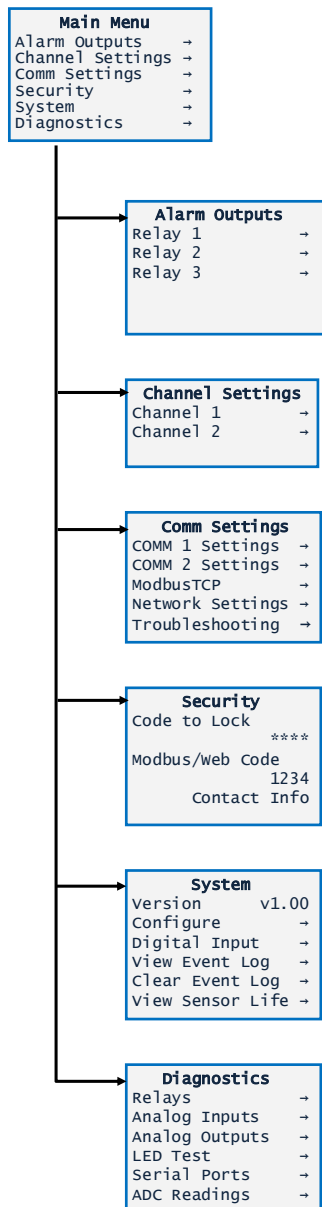

Alarm Output Menu – contains settings that control the four optional alarm relays (if installed). These setting include relay programming, on and off delay, failsafe mode and specific input override. (NOT USED IN THIS PRODUCT)

Channel Settings Menu – contains settings specific to each channel. These include tag names, range, calibration settings and alarm levels. (SEE NEXT PAGE)

Comm Settings Menu – contains settings specific to the Ethernet network interface, MODBUS/TCP interface and optional RS-485 serial ports (FACTORY SETTINGS – DO NOT MODIFY)

Security Settings Menu – allows the user to restrict operation for some or all of the features as well as provide a programmed contact name. (FACTORY SETTINGS – DO NOT MODIFY)

System Settings Menu – contains settings that are unit specific. These include unit name. time and date, warm-up and calibration delay settings, and Event Log. (FACTORY SETTINGS – DO NOT MODIFY)

Diagnostics Menu – comprehensive set of tools that can be used to activate relays, simulate output values and test serial ports.

GASMAX CHANNEL SETTINGS MENU

The Channel Settings Menu allows the user to adjust individual channel or sensor-specific features. Data in the Channel Settings Menu is uploaded from Smart Sensors, and written back to any local Smart Sensor if changed in the menu.

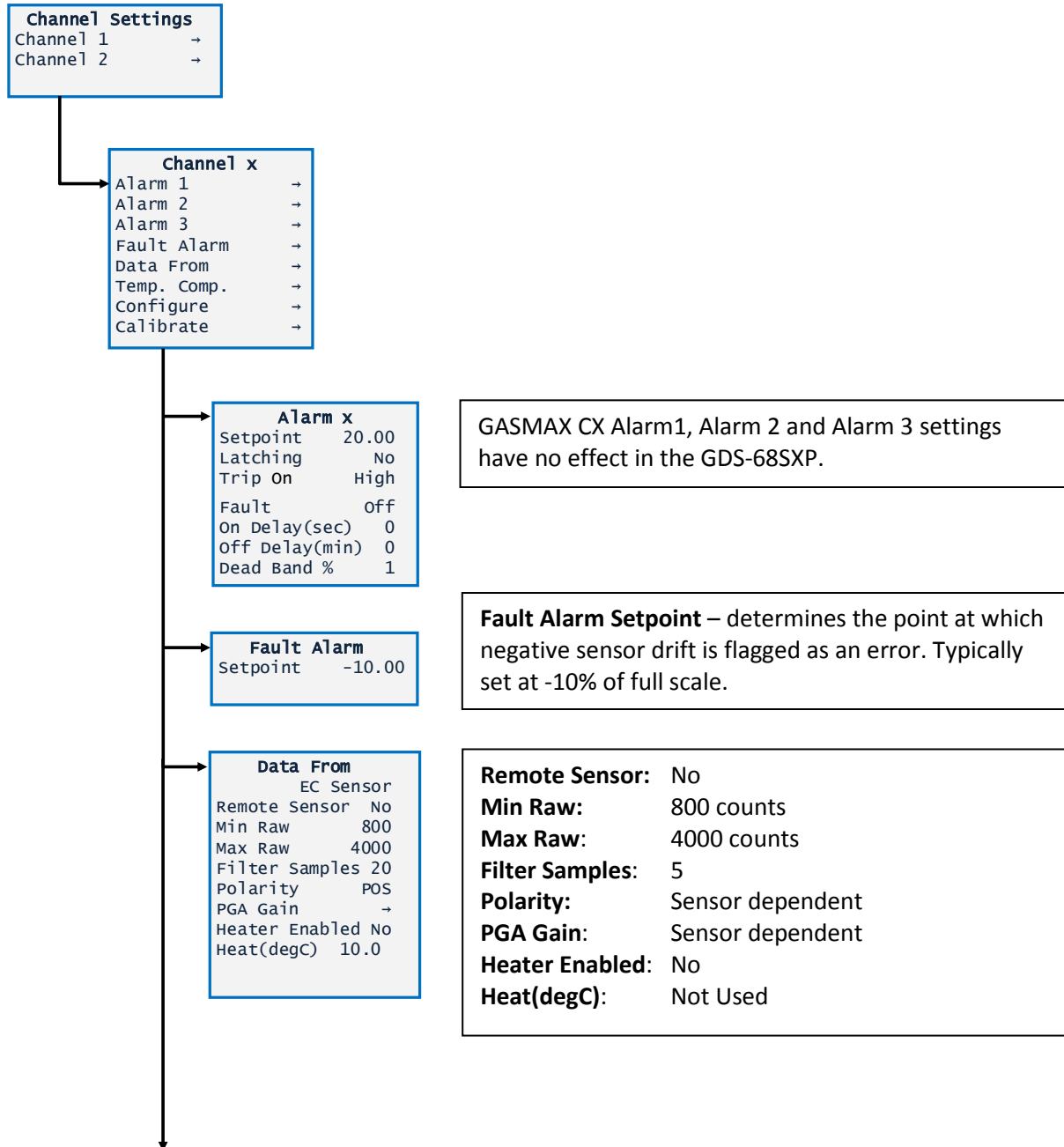

Temp. Comp.		
Temp	Gain	Offset
-40	1.00	+0.00
-30	1.00	+0.00
-20	1.00	+0.00
-10	1.00	+0.00
0	1.00	+0.00
+10	1.00	+0.00
+20	1.00	+0.00
+30	1.00	+0.00
+40	1.00	+0.00
+50	1.00	+0.00

Temperature Compensation compensates for changes in sensor output (gain) and zero value (offset) as sensor temperature changes. These values are uploaded from the sensor and should not be changed.

Configure	
Hydrogen Sulfide	
E. Units	ppmH2S
Zero	0.00
Span	100.0
Decimal Points	0
Channel On?	Yes
Deadband (%)	0.00
Backup/Restore	→

Tag Name: User programmable text field
E. Units: Engineering Units from sensor.
Zero: 0.00
Span: Max value from sensor
Decimal Points: Number of digits from sensor.
Channel On?: YES
Dead band (%): 0%

Calibrate	
Offset	1.73
Gain	1.00
Cal Zero	0.00
Cal Span	100.0
Set Unity Gain	→

Offset: Calculated offset from last Cal
Gain: Calculated gain from last Cal
Cal Zero: Cal Zero Value for sensor Cal
Cal Span: Cal Span Value for sensor Cal
Set Unity Gain: Resets gain and offset to default

GASMAX COMM SETTINGS MENU

The Comm Settings Menu allows the user to configure the RS-485 slave serial interface used by the GDS-68SXP master to read GASMAX real-time values and fixed data uploaded from the GDS Corp Smart Sensor. **DO NOT MODIFY** these settings unless told to do so by GDS Corp personnel to assist in troubleshooting or gas sensor debugging.

Comm Settings	
COMM 1 Settings	→
COMM 2 Settings	→
ModbusTCP	→
Network Settings	→
Troubleshooting	→

COMMx Settings	
Modbus Slave	
BaudRate	9600
Parity	None
Slave ID	42
Byte Order	BADC
Enable LEDs	Yes

Comm Type:	MODBUS Slave
Baud Rate:	9600 baud
Slave ID:	1
Byte Order:	ABCD
Enable LEDs:	YES

ModbusTCP	
Slave	
Byte Order	BADC
Master	
Timeout(ms)	500
Poll Dly(ms)	250
Enable LEDs	Yes

Slave Settings:	
Byte Order:	Not Used
Master Settings:	
Timeout:	Not Used
Poll Delay:	Not Used
Enable LEDs:	NO

Network Settings	
DHCP Enabled	Yes
Hostname	Unit-44-1000
Ip Address	169.254.100.10
Netmask	254.254.0.0

DHCP Enabled:	NO
Hostname:	Not Used
IP Address:	Not Used
Net mask:	Not Used
Gateway:	Not Used

Troubleshooting	
View Error Count	
Clear Error Count	

View Error Count	– View a menu that tracks the number of network errors
Clear Error Count	– Resets number of network errors to zero.

GASMAX SYSTEM SETTINGS MENU

The System Settings menu allows the user to view or modify certain system settings. Except for Time and Date, DO NOT modify these settings unless told to do so by GDS Corp personnel to assist in troubleshooting or gas sensor debugging.

```

System
Version      v1.00
Configure    →
Digital Input →
View Event Log →
Clear Event Log →
View Sensor Life →
    
```

```

Configure
Unit-44-1000
Date      01/25/2013
Time      04:33:05
Warmup(m) 1
Cal Purge(m) 1
Block Neg No
Send SensrLife No
InCal mA 0.00
Alm Refresh(m) 0
    
```

Date & Time: Sets the GASMAX CX date and time.
Warm Up Delay: Set for 1 Min
Cal Purge Delay: Set for 1 Min
Block Negative: No
Send Sensor Life: No
InCal mA : 1.5 mA
Alarm Refresh : 0

```

Digital Input
Mode Flt Override
Normally Open
Channel Ch. 1 & 2
    
```

Not Used. Do Not Modify.

```

Hh:mm Ch Event
01/25/2013
03:35 2 Fault Out
03:34 2 Fault In
03:33 2 Fault Out
03:32 2 Fault In
    
```

Event Log – Shows Gas sensor events and related time & date
Clear Event Log – Clears all entries in the event log.

```

Ch.1 Sensr Found
Life: 100%
-----
Ch.2 No Sensor
    
```

Sensor Life – Computed value based on initial stored 'gain' value when sensor was first calibrated. If new gain equals original gain, sensor life = 100%. If new gain equals twice original gain, sensor life = 0%.

GASMAX DIAGNOSTICS MENU

The Diagnostics page provides tools for use during setup or testing. Tests for optional features are not available if the feature is not installed. Some of these tests may be useful in certain debugging operations.

Diagnostics	
Relays	→
Analog Inputs	→
Analog Outputs	→
LED Test	→
Serial Ports	→
ADC Readings	→

!! Warning !!
 Diagnostic mode.
 Alarms will not
 Be processed.
 Edit (OK)
 Next (Cancel)

**WARNING – ENTERING DIAGNOSTICS MODE
 DISABLED ALARM FUNCTION AND REQUIRES A
 DEVICE REBOOT ON EXIT.**

Relays	
Relay 1	off
Relay 2	off
Relay 3	Off
Fault Relay	On

Relays Menu (Not Available)

Ch.1 EC - Loc	
Counts:	856
Temp:	24.5 degC

Ch.2 4-20mA	
Counts:	0
Current:	0.00mA

Shows current input readings for channel 1
 Channel 2 disabled.

Analog Outputs	
4-20mA Out1	0mA
4-20mA Out2	0mA

Out1 Fdbk	0.07
Out2 Fdbk	0.06

Shows the live output values on analog channel
 1 and analog channel 2. Also shows the
 feedback monitor reading for both channels.

LED Test

Cycles the external LEDs.

Comm Test	
Connect Loopback	
Port 1 => 2:	Bad
Port 2 => 1:	Bad

Not Available

420 Out1:	4.60mA
Fdbk 1:	4.57mA
420 Out2:	4.05mA
Fdbk 2:	4.14mA
Sensor V:	0.01V
SensrAmp:	0.78V
PSU:	22.93V

Displays values read by internal A/D converters

19 GDS-68SXP MODBUS REGISTERS

The GDS-68SXP Process / Odorant Monitor features a set of user-accessible MODBUS registers that can provide a complete snapshot of the system configuration. This includes all real-time data, preset zero, span and calibration values and user-programmable text.

Description	Register	Write	Details
WRITE REGISTERS			
Start Measurement Cycle	1000	W	Writing a "1" to this register will start a measurement cycle
Stop Measurement Cycle	1010	W	Writing a "1" to this register will cancel a measurement cycle in progress
Start Calibration Cycle	1020	W	Writing a "1" to this register will start a calibration cycle
Stop Calibration Cycle	1030	W	Writing a "1" to this register will start cancel a calibration cycle in progress
Set Calibration Source = Port	1040	W	Writing a "1" to this register will set the calibration gas source to "Cal Port"
Set Calibration Source = Stream	1050	W	Writing a "1" to this register will set the calibration gas source to "Sample Stream"
			Note: Writes will have no effect if MODBUS Write Enable is set to "No"
READ REGISTERS (Realtime)			
Current Counts	31001	N/A	12-bit value; 800 = 4mA, 4000 = 20mA
Current Reading	31002	N/A	32-Bit floating-point value
Current Alarm Status	31004	N/A	"1" = Alarms Clear "2" = Alarm 1 Active "3" = Alarm 2 Active "4" = Alarm 3 Active "5" = Fault Alarm Active
Current Mode	31005	N/A	Integer (Contact factory for details)
Current Time Hour	31006	N/A	Decimal value of current hour
Current Time Minute	31007	N/A	Decimal value of current minute
Current Time AM/PM	31008	N/A	"0" = AM "1" = PM
Current Time Month	31009	N/A	Decimal value of current month
Current Time Day	31010	N/A	Decimal value of current day
Current Time Year	31011	N/A	Decimal value of current year
Currently Measuring	31012	N/A	"1" = Measurement cycle
Currently Calibrating	31013	N/A	"1" = Calibration cycle
Manual Operation Allowed	31014	N/A	"1" = Ready
Hours Remaining to Sample	31015	N/A	Decimal value of hours to go to next sample

Minutes Remaining to Sample	31016	N/A	Decimal value of minutes to go to next sample
Seconds Remaining to Sample	31017	N/A	Decimal value of seconds to go to next sample
READ REGISTERS (Configuration)			
Full Scale Range	31021	N/A	32-Bit floating-point value
System Response Factor	31023	N/A	32-Bit floating-point value
System Cal Gain Value	31025	N/A	32-Bit floating-point value
System Cal Offset Value	31027	N/A	32-Bit floating-point value
System Sample Interval	31029	N/A	"1" = One Hour "2" = Two Hours "3" = Three Hours "4" = Four Hours "5" = Six Hours "6" = Eight Hours "7" = Twelve Hours "8" = Twenty-four Hours
System Decimal Points	31030	N/A	"0" = "000" "1" = "00.0" "2" = "0.00"
System Alarm 1 Value	31031	N/A	32-Bit floating-point value
System Alarm 1 Type	31033	N/A	"0" = Alarm above "1" = Alarm below
System Alarm 2 Value	31034	N/A	32-Bit floating-point value
System Alarm 2 Type	31036	N/A	"0" = Alarm above "1" = Alarm below
System Alarm 3 Value	31037	N/A	32-Bit floating-point value
System Alarm 3 Type	31039	N/A	"0" = Alarm above "1" = Alarm below
Firmware Version	31040	N/A	Decimal value
Security Level	31041	N/A	"1" = Low Security "2" = Medium Security "3" = High Security
Modbus Write Enable	31042	N/A	"0" = MODBUS writes disabled "1" = MODBUS writes enabled
READ REGISTERS (Last Sample)			
Last Sample Reading	31051	N/A	32-Bit floating-point value
Last Sample Error Flags	31053	N/A	Bit 0 = Sensor Fault Bit 1 = Flow Switch Fault Bit 2 = Gas Flow Fault Bit 3 = Air Flow Fault Bit 4 = Reserved (0) Bit 5 = Reserved (0) Bit 6 = Reserved (0) Bit 7 = Reserved (0) Bit 8 = Offset Warning

			Bit 9 = Overrange Warning Bit 10 = Zero Timeout Warning Bit 11 = Sample Timeout Warning Bit 12 = Recovery Timeout Warning Bit 13 = GASMAX Warning Bit 14 = Reserved (0) Bit 15 = Reserved ("0")
Last Sample Raw Zero	31054	N/A	32-Bit floating-point value
Last Sample Raw Measurement	31056	N/A	32-Bit floating-point value
Last Sample Time Hour	31058	N/A	Decimal value of hour at last sample
Last Sample Time Minute	31059	N/A	Decimal value of minute at last sample
Last Sample AM/PM	31060	N/A	"0" = AM "1" = PM
Last Sample Time Month	31061	N/A	Decimal value of month at last sample
Last Sample Time Day	31062	N/A	Decimal value of day at last sample
Last Sample Time Year	31063	N/A	Decimal value of year at last sample
Last Sample Zero Time	31064	N/A	Decimal value of time to complete zero measurement
Last Sample Meas Time	31065	N/A	Decimal value of time to complete sample measurement
Last Sample Flush Time	31066	N/A	Decimal value of time to complete flush to 10% of scale
Last Sample Gas Flow Status	31067	N/A	"0" = Flow Error "1" = Flow OK
Last Sample Air Flow Status	31068	N/A	"0" = Flow Error "1" = Flow OK
Last Sample Sensor Temperature	31069	N/A	32-Bit floating-point value
Last Sample DC Volts	31071	N/A	32-Bit floating-point value
Last Sample Sequence Number	31073	N/A	Decimal count of samples since power-up
READ REGISTERS (Last Cal)			
Last Cal Span Value	31081	N/A	32-Bit floating-point value
Last Cal Error Flags	31083	N/A	Bit 0 = Sensor Fault Bit 1 = Flow Switch Fault Bit 2 = Gas Flow Fault Bit 3 = Air Flow Fault Bit 4 = Reserved (0) Bit 5 = Reserved (0) Bit 6 = Cal Zero Calculation Fault Bit 7 = Cal Span Calculation Fault Bit 8 = Offset Warning Bit 9 = Overrange Warning Bit 10 = Zero Timeout Warning Bit 11 = Sample Timeout Warning Bit 12 = Recovery Timeout Warning Bit 13 = GASMAX Warning

			Bit 14 = Reserved (0) Bit 15 = Reserved ("0")
Last Cal Raw Zero	31084	N/A	32-Bit floating-point value
Last Cal Raw Measurement	31086	N/A	32-Bit floating-point value
Last Cal Time Hour	31088	N/A	Decimal value of hour at last Cal
Last Cal Time Minute	31089	N/A	Decimal value of minute at last Cal
Last Cal AM/PM	31090	N/A	AM or PM indicator
Last Cal Time Month	31091	N/A	Decimal value of month at last Cal
Last Cal Time Day	31092	N/A	Decimal value of day at last Cal
Last Cal Time Year	31093	N/A	Decimal value of year at last Cal
Last Cal Zero Time	31094	N/A	Decimal value of time to complete zero measurement
Last Cal Meas Time	31095	N/A	Decimal value of time to complete sample measurement
Last Cal Flush Time	31096	N/A	Decimal value of time to complete flush to 10% of scale
Last Cal Gas Flow Status	31097	N/A	"0" = Flow Error "1" = Flow OK
Last Cal Air Flow Status	31098	N/A	"0" = Flow Error "1" = Flow OK
Last Cal Sensor Temperature	31099	N/A	32-Bit floating-point value
Last Cal DC Volts	31101	N/A	32-Bit floating-point value
Last Cal Gain	31103	N/A	32-Bit floating-point value
Last Cal Offset	31105	N/A	32-Bit floating-point value
Last Cal Sequence Number	31107	N/A	Decimal count of calibrations since power-up
READ REGISTERS (Cal Config)			
Calibration Type	31121	N/A	"1" = Manual calibration "2" = Once calibration "3" = Automatic calibration
Cal Span Value	31122	N/A	32-Bit floating-point value
Cal Source	31124	N/A	"1" = Sample Stream "2" = Cal Port
READ REGISTERS (Cal Config)			
GASMAX reading	31201	N/A	GASMAX current counts (0-4000, 800 = "0")
GASMAX reading	31202	N/A	32-Bit floating-point value
GASMAX sensor life	31204	N/A	Sensor life (0-100)
READ REGISTERS (Ascii Text)			
Instrument Name	41001	N/A	20-character packed string ("GDS-68SXP")
Engineering Units	41011	N/A	10-character packed string ("lbs/mmcf")
Unit Serial Number	41016	N/A	10-character packed string ("GDS100001")

20 TROUBLESHOOTING GUIDELINES

NEGATIVE READING ON GDS-68SXP DISPLAY

- A negative output indicates an error in the most recent measurement cycle. Review the chapter on Maintenance to determine the cause.

FAULT INDICATION ON GASMAX DISPLAY

- Fault or Over-range on power-up. Certain toxic sensors indicate off-scale low or high at power up and quickly drift towards zero. This is normal behavior and should resolve itself in less than an hour for most sensors.
- Continuous Fault indication. Remove sensor and examine for moisture or discoloration. Replace sensor if wet or discolored. Fault indication generally indicates sensor useful life is exhausted.
- Sensors left unpowered for more than 3 months are subject to accelerated degradation and may demonstrate a permanent loss of sensitivity.

FAILED GAS SENSOR CALIBRATION

- Sensor reading during zero calibration exceeds upper limit of zero – sensor is defective and should be replaced.
- Sensor reading during span calibration too low – sensor may be defective. However, it may be possible to *temporarily* continue operation by increasing GASMAX CX SENSOR PREAMP GAIN.

FAILED SYSTEM CALIBRATION

- Check the “Last Cal” screen for detailed information on the most recent calibration cycle.
- Insufficient difference between zero value and span value. Difference must be at least 10% of scale.
- Calibration gas may be out of date, defective or depleted
- Purge air inlet may be clogged

ANALOG 4-20MA OUTPUT NOT WORKING OR NOT ACCURATE

- No output: Check to make sure that the output wiring connection to the 4-20mA output terminal is secure.
- Readings Don't Match: Verify that the full-scale range of the GDS-68SXP and input range of the receiving controller or DCS is identical. Use the Diagnostics Menu to force the 4-20mA output to specific values and confirm the reading on the remote controller or DCS.
- Readings are “Off”: Use the Analog Adjustment function in the Diagnostics Menu to adjust the 4-20mA output to match the specific input load resistor of the receiving controller or DCS.

MODBUS DATA INCORRECT OR MISSING

- Check for incorrect MODBUS polarity (swap “A” and “B” if unsure; no damage will occur)
- Verify that the Baud Rate, Parity, Data bits and Slave ID value are correct.
- Make sure there are no other MODBUS slaves on the same network with similar Slave ID settings
- Verify that MODBUS master is requesting data from correct data register.
- If reading the digital counts value, verify that controller MIN and MAX count settings are correct. MIN counts should be “800” which corresponds to 4mA and MAX counts should be “4000” which corresponds to 20 mA.
- If reading MODBUS floating point, verify that the Byte Order setting is correct.

GDS-68SXP DISPLAY BLANK

- Verify DC power at input supply terminals on back of GDS-68SXP board assembly.
- Verify ribbon cable plugged into Display board and pump board.

GASMAX DISPLAY BLANK

- Verify DC power at input supply terminals on GDS-68SXP board.
- Verify power and MODBUS wiring between GDS-68SXP board and GASMAX CX

SYSTEM COMM TIMEOUT MESSAGE

- Verify MODBUS wiring between GDS-68SXP board and GASMAX CX
- Verify GASMAX Comm 1 serial port programming for correct Baud Rate and Slave ID.

GDS-68SXP POWER FAIL MESSAGE

- Verify DC input voltage too high (POWER FAIL HI) or too low (POWER FAIL LOW). Once power fail occurs, system must be restarted to restore operation.

21 GDS CONNECT 68SXP APPLICATION FOR IPHONE

The GDS-68SXP includes a wireless interface that supports remote access via the GDS Connect 68SXP iPhone application. The GDS Connect application allows users to view and graph measurement data, change settings (if write-enabled) and send a snapshot of configuration and measurement data via email.

The GDS Connect 68SXP application is available from the Apple Apps Store and is free of charge.

Once installed, click in the icon to get started. Press "Scan" to identify any local GDS-68SXP units, then select the unit from the list. Once connected, the app will display the current reading and unit status, history graph and tabular data, detailed information on the last sample and last calibration and a set of tools and troubleshooting information that can be helpful in the field. See the Communications menu for more wireless settings options.

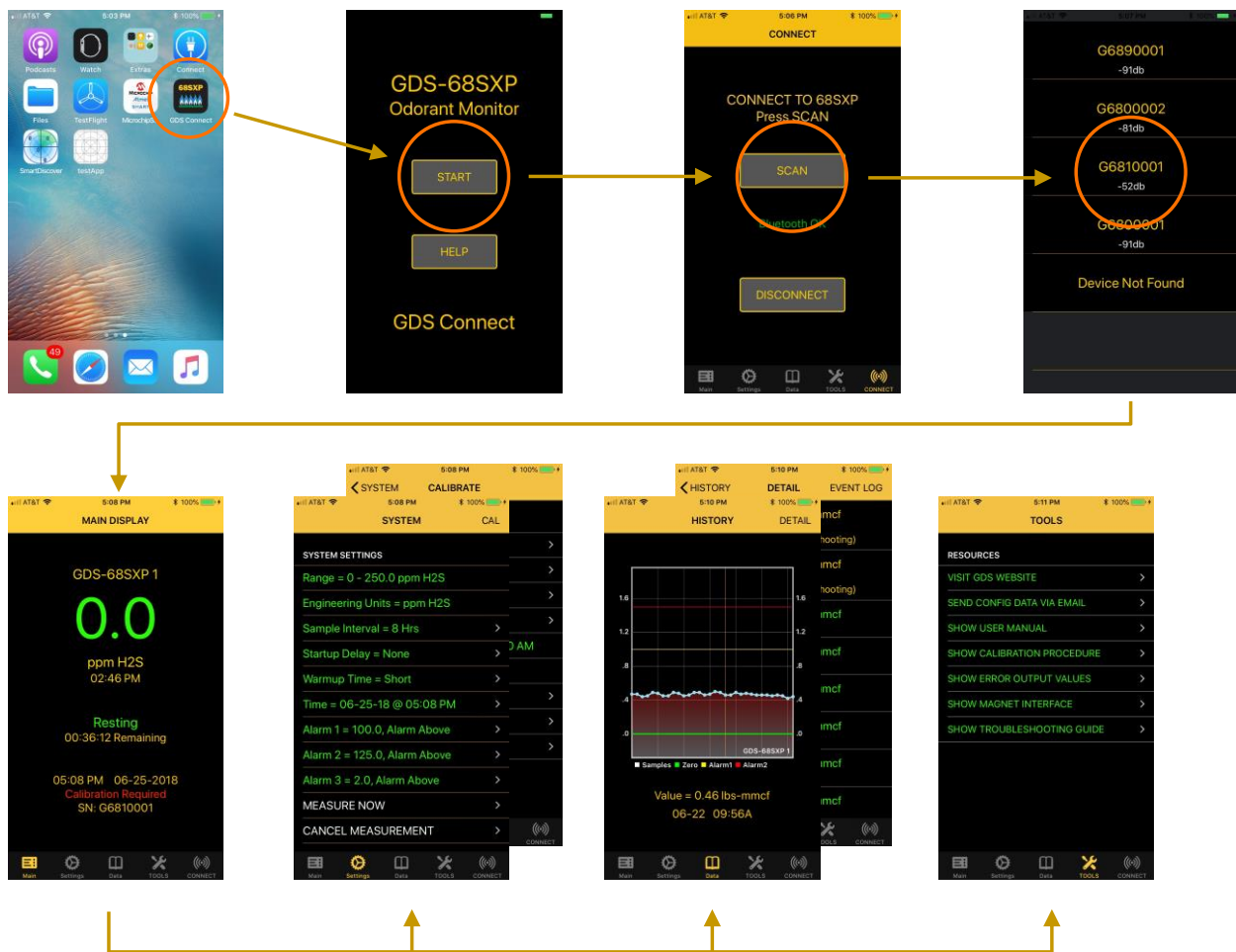

Figure 21-1: GDS Connect iOS App

22 SYSTEM DIMENSIONS

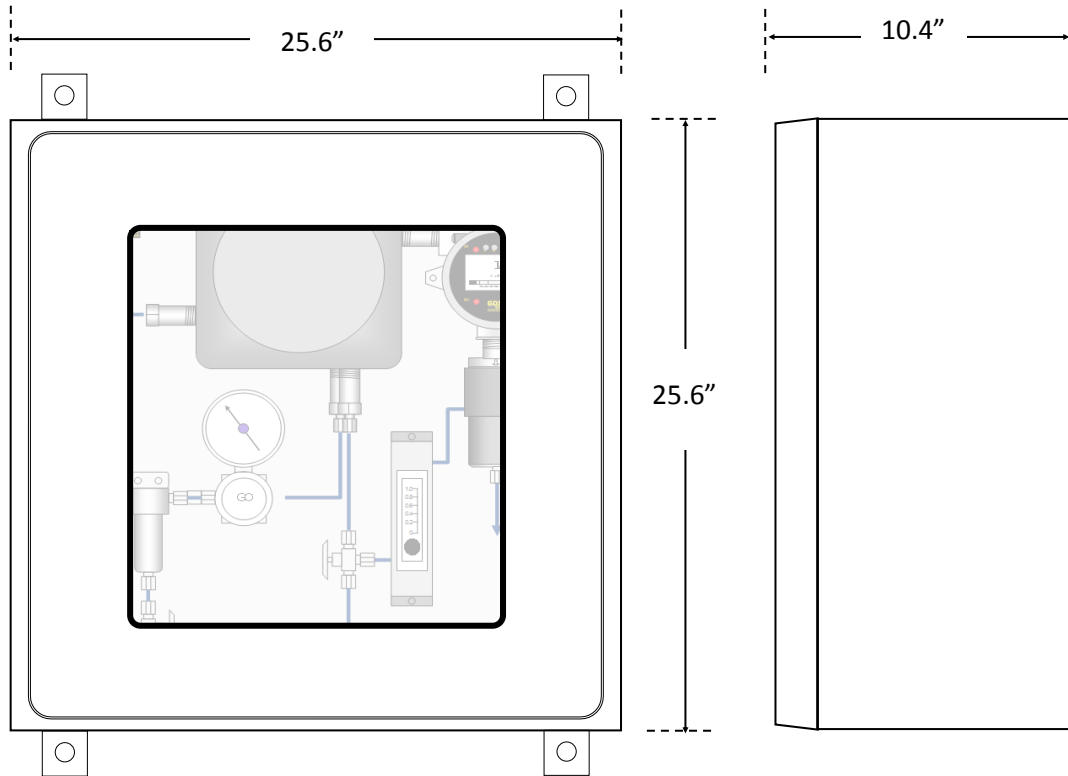

Figure 22-1: GDS-68SXP Dimensions With Wall-Mount Kit

23 GASMAX CX FACTORY DEFAULT SETUP

Values shown are for units configured for a range of 0-50 mg/m³. For alternative ranges, modify the SPAN, ENGINEERING UNITS, CAL SPAN VALUE and ALARM LEVEL settings as necessary.

Menu	Setting	Value
Alarm Outputs Menu		
Relay 1, Relay 2, Relay 3	Alarm 1	Off
	Alarm 2	Off
	Alarm 3	Off
	Fault	Off
Channel Settings Menu		
Channel 1		
Alarm 1, Alarm 2, Alarm 3	Setpoint	<Full Scale>
	Latching	No
	Trip On	High
	On Delay	0 (None)
	Off Delay	0 (None)
	Deadband	1%
Fault Alarm	Setpoint	-10% of Scale
Data From	Sensor Type	EC Sensor
	Min Raw	800
	Max Raw	4000
	Filter	30
	Polarity	POS
	PGA Gain	<TBD>
	Heater En.	No
	Heat (degC)	10.00
	Local Cal?	Yes
Temperature Comp (°C)		
-40	Gain / Offset	<TBD>
-30	Gain / Offset	<TBD>
-20	Gain / Offset	<TBD>
-10	Gain / Offset	<TBD>
0	Gain / Offset	<TBD>
+10	Gain / Offset	<TBD>
+20	Gain / Offset	<TBD>
+30	Gain / Offset	<TBD>
+40	Gain / Offset	<TBD>
+50	Gain / Offset	<TBD>

	Configure	Tag Name	Raw Sensor
		Eunits	<TBD>
		Zero	0
		Span	<TBD>
		Decimal Points	<TBD>
		Channel On?	Yes
		Deadband	0%
		In-Cal mA	1.5 mA
	Calibrate	Cal Offset	<TBD>
		Cal Gain	<TBD>
		Cal Zero	0.0
		Cal Span	<TBD>
	Channel 2	Channel On?	No
	Comm Settings Menu		
	Comm 1	Type	MB Slave
		Baud Rate	9600
		Parity	None
		Timeout	500
		Poll Delay	250
		Byte Order	ABCD
		Enable LEDs	No
	Comm 2	Type	MB Slave
		Baud Rate	9600
		Parity	None
		Timeout	500
		Poll Delay	250
		Byte Order	BADC
		Enable LEDs	No
	MODBUS / TCP	Slave	
		Byte Order	BADC
		Master	
		Timeout	500
		Poll Delay	250
		Enable LEDs	Yes
	Network Settings	DHCP Enabled?	Yes
		Hostname	GDS-68SXP
		IP Address	N/A
		Netmask	N/A

		Gateway	N/A
	Security Menu		
		Lock Code	****
		MB/Web Code	1234
		Contact Info	Default
	System Menu		
	Configure	System name	GDS68SXP
		Date	Date
		Time	Time
		Warmup (m)	1
		Cal Purge (m)	3
		Block Negative	No
		Send Sensor Life	No
		Alarm Refresh	0
	Digital Input	Mode	Alarm Reset

24 SYSTEM EVENTS

Event	Description	Recommended Action
"0.00"	Value from reading (no text)	Result of successful measurement
A1 IN	Alarm 1 In (made active)	User defined
A1 OT	Alarm 1 Out (made inactive)	User defined
A2 IN	Alarm 2 In (made active)	User defined
A2 OT	Alarm 2 Out (made inactive)	User defined
A3 IN	Alarm 3 In (made active)	User defined
A3 OT	Alarm 3 Out (made inactive)	User defined
FLTIN	Fault Alarm In (made active)	User defined
FLTOT	Fault Alarm Out (made inactive)	User defined
CALOK	Calibration cycle completed successfully	Normal operation
CALCN	Calibration cycle cancelled	User action
CALCL	Calibration values reset (Gain = 1.00)	User action
CALSA	Calibration cycle started automatically	None
CALSM	Calibration cycle started via MODBUS	User action
CALSU	Calibration cycle started via user from main menu	User action
CALSW	Calibration cycle started via wireless interface	User action
CBOOT	Unit performed Cold Boot	User reset to factory default values.
CFAIR	Calibration FAIL (Purge air flow)	No purge air during calibration cycle. Check air pump and flame arrestors.
CFFSW	Calibration FAIL (Stuck flow switch)	Flow switch stuck in OPEN position. Check in diagnostics mode. Replace if necessary.
CFGAS	Calibration FAIL (Span gas flow)	No span flow during calibration cycle. Check cal cylinder or source of cal gas.
CFSEN	Calibration FAIL (Sensor fault)	Sensor FAULT during calibration cycle. Check or recalibrate sensor.
CFZER	Calibration FAIL (Sensor resting zero exceeds limits)	Resting zero too high or too low. Check or recalibrate sensor.
CFSPN	Calibration FAIL (Calculated GAIN exceeds limits)	Sensor output too high or too low during system cal. Recalibrate sensor.
CWOFF	Calibration WARN (Excessive sensor offset)	Sensor resting zero above nominal value. Check or recalibrate sensor.
CWOVR	Calibration WARN (Overrange during cycle)	Input > full scale during calibration cycle. Check range and calibration gas.
CWMTO	Calibration WARN (Measurement timeout)	Measurement time exceeded limit. Check or replace sensor.
CWRTO	Calibration WARN (Recovery timeout)	Recovery time exceeded limit. Check or replace sensor.

CWZTO	Calibration WARN (Zero timeout)	Zero measurement time exceeded limit. Check or replace sensor.
COMER	Controller failed to communicate with GMCX.	Check wiring and GMCX Comm settings
FBOOT	Unit performed Factory Cold Boot.	Contact GDS Corp.
GMCAL	GASMAX CX calibration cycle detected	User action
LOGCL	Event log cleared by user from main menu	User action
PWRLO	DC input power below 18.0VDC	Check DC power for 24V +/- 5%
PWRHI	DC input power above 30.0VDC	Check DC power for 24V +/- 5%
SBUMP	Sensor bump cycle recorded	Normal during rest if BUMP enabled
SEQAW	Measurement cycle abort via wireless interface	User action
SEQAM	Measurement cycle abort via MODBUS	User action
SEQAU	Measurement cycle abort via user from main menu	User action
SEQSM	Measurement cycle started via MODBUS	User action
SEQSU	Measurement cycle started by user from menu.	User action
SEQSW	Measurement cycle started via wireless interface	User action
SFAIR	Measurement cycle FAULT* (Purge air flow)	No purge air during measurement cycle. Check air pump and flame arrestors.
SFFSW	Measurement cycle FAULT* (Flow switch)	Flow switch stuck in OPEN position. Check in diagnostics mode. Replace if necessary.
SFGAS	Measurement cycle FAULT* (Sample gas flow)	Check inlet valve and sample regulator setting for proper flow.
SFSEN	Measurement cycle FAULT* (Sensor)	Sensor FAULT during measurement cycle. Check or recalibrate sensor.
SWOFF	Measurement cycle WARN (High sensor zero)	Sensor resting zero above nominal value. Check or recalibrate sensor.
SWOVR	Measurement cycle WARN (Overrange during cycle)	Input exceeded full scale during measurement cycle. Check range.
SWMTO	Measurement cycle WARN (Measurement timeout)	Measurement time exceeded limit. Check or replace sensor.
SWRTO	Measurement cycle WARN (Recovery timeout)	Recovery time exceeded limit. Check or replace sensor.
SWZTO	Measurement cycle WARN (Zero timeout)	Zero measurement time exceeded limit. Check or replace sensor.
SENER	Sensor failed to stabilize during warmup time.	Check or replace sensor.
STUOK	Startup OK	Signifies unit passed all startup tests.
WCERR	Wireless chip initialization error	Contact GDS Corp
WCINI	Wireless chip initialization (during Cold Boot)	Normal
NOTE: Only Measurement FAULT* errors will result in a FAULT output from the GDS-68SXP. Warning conditions will be recorded in the Event Log and in the Sample Error Flags value.		

25 KNOWN ERRATA

GASMAX CX

Version 1.19

1. No errata noted.

GDS-68SXP

Version 1.04

1. The MODBUS slave interface is preset for 9600 baud, no parity and 8 data bits and cannot be changed.

This page intentionally blank

